



HEWLETT
PACKARD

HP 3708A
Noise and Interference
Test Set
(Including Option 001)
Operating Manual

MANUAL IDENTIFICATION

Model Number: HP 3708A
 Date Printed: Aug 84
 Part Number: 03708-90001

Operating Manual

MANUAL CHANGE IDENTIFICATION

Part Number: 03708-90005



This supplement contains important information for correcting manual errors and for adapting the manual to instruments containing improvements made after the printing of the manual.

To use this supplement:

Make all ERRATA corrections.

Make all appropriate serial number related changes indicated in the tables below.

Serial Prefix or Number	Make Manual Changes	Serial Prefix or Number	Make Manual Changes
2515U00331	1		
2515U00779	1-2*		

* NEW ITEM

NOTE

Manual change supplements are revised as often as necessary to keep manuals as current and accurate as possible. Hewlett-Packard recommends that you periodically request the latest edition of the supplement. Free copies are available from all HP offices. When requesting copies quote the manual identification information from your supplement or the model number and print date from the title page of the manual.

29 Nov 1989

Page 1 of 6



ERRATA

Page 6:

Change item 7 to:

DISP C - This displays the Carrier Power present at the front panel IF INPUT.

Note: If a carrier has been entered using the ENTER C key, the DISP C does not display the entered value but shows -41.00dBm ie. the lowest carrier level in C/N mode.

Page 11:

Add the following note to go along with item 38, IF INPUT:

NOTE

Do not leave unterminated cables connected to the IF INPUT.

Page 13:

Add the following to the CALIBRATION description:

The CALIBRATE indicator flashes when CAL INHIBIT is selected and a temperature calibration is requested. The instrument performs a calibration cycle when the CAL INHIBIT is deselected.

Page 20:

Add the following to the POWER METER ZERO CALIBRATION:

CAUTION: The use of a long cable to calibrate the power meter results in the NOISE OUTPUT being decalibrated.

Page 42, Table 4-1:

Change: ENTER N BW (external filter) value to 310MHz.

Add the following note below Table:

Note: The Default Parameters for Carrier to Noise Ratio (C/N), SYSTEM BW and Noise Power (N) are typical values and may vary from instrument to instrument.

Pages 43 and 44:

Replace these pages with the attached pages.

Page 54, Table 6-4:

Add to the Meaning for Bit 0:

or temperature calibration is requested with CAL INHIBIT selected.

Add to the Meaning for Bit 2:

or measured noise bandwidth is less than 0.05MHz.

Page 55:

In paragraph SRQ MASK change:

"SRQ MASK N ENT" or "SRQ MASK", N "ENT" to

"SRQ MASK N ENT" or "SRQ MASK", N, "ENT"

ERRATA (continued)

Page 56, Table 6-5:

Change: ENTER N BW (external filter) value to 310MHz.

Add the following note below Table:

Note: The Default Settings for Carrier to Noise Ratio (C/N), SYSTEM BW and Noise Power (N) are typical values and may vary from instrument to instrument.

Page 60:

Change: the default value for ENTER N BW to 310MHz.

Delete: last line "This is the default selection."

Page 61:

Change the Description for NOISE BAND 70 +/-20 to:

Selects the 70 +/-20MHz Noise Band. "ENT" is not necessary. This is the default selection.

Page 62:

Add to Table 6-7:

Function	HP-IB Code	Description
INSTRUMENT STATUS	PROG?	Allows reading of the current instrument settings.

Page 64, Table 6-7, SERVICE REQUEST MASK:

Add to SRQ Condition enabled for Bit 0: or calibration request

Page 64:

Change: OUTPUT 708; "SRQ MASK 255 "ENT" to
OUTPUT 708; "SRQ MASK 255 ENT"

*Page 72:

The warranted performance characteristic for the Carrier Path (group delay) has been changed to a supplemental characteristic. The group delay specification is now described, in Table 7-1 Specifications, as follows:

Group delay

Typically 0.2ns for ranges 70 +/-20MHz, 140 +/-40MHz.

*Page 73:

The warranted performance characteristic for the Connectors has been changed to a supplemental characteristic. The connector specification is now described, in Table 7-1 Specifications, as follows:

Connectors

All signal connectors in the HP 3708A are BNC type and have a return loss typically >26dB (except the rear panel Aux Interferer Input, with a return loss of 18dB typically).

Page 73:

Add: OPTION W30 This option is available at the time of purchase and gives a 3 year Extended Hardware Support. It provides 2 additional years of return-to-HP hardware service support for (2nd and 3rd years).

ERRATA (continued)

Page 77:

Add part numbers to Figure 8-1:

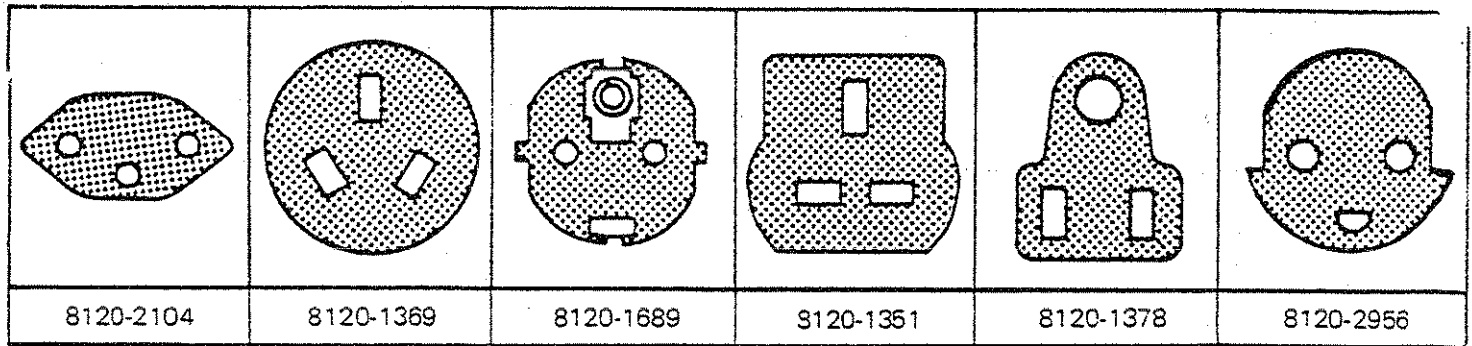

Figure 8-1 Power Receptacles

CHANGE 1

This change relates to firmware revision 2610. On instruments on and above serial number 2515U00331, change the following default parameters:-

Page 42; Table 4-1 3708A Default Parameters:

- a) Carrier to Noise Ratio (C/N) 42dB
- b) Carrier to Noise Density (C/No) 120dBHz
- c) Energy per bit to Noise Density (Eb/No) 50dB.

Page 56; Table 6-5 Instrument Parameter Default Settings:

- a) Carrier to Noise Ratio (C/N) 42dB
- b) Carrier to Noise Density (C/No) 120dBHz
- c) Energy per bit to Noise Density (Eb/No) 50dB.

CHANGE 2

This change relates to firmware revision 2841. On instruments on and above serial number 2515U00779 and instruments fitted with Rev 2841 firmware, change the default parameter for the C/I ratio:-

Page 42, Table 4-1 3708A Default Parameters:

Carrier to Interference C/I 60dB

Page 56, Table 6-5 Instrument Parameter Default Settings:

Carrier to Interference (C/I) 60dB

Page 59, Table 6-6 3708A Data Message Commands (Key Action):

The C/I default value is now 60dB.

5 OPERATOR'S CHECKS

DESCRIPTION

The main operating functions of the HP 3708A are verified using the following test equipment and procedure. These quick operator's checks are not intended to be a performance test of the instruments specification but an indication that the instrument is functional.

Steps 1 to 3 check the Power Meter linearity.

Step 5 checks the Noise Power accuracy at 0dBm.

Steps 6 to 8 check the Noise Power accuracy at various levels and gives a qualitative display of the NOISE BAND on a spectrum analyser.

Steps 9 to 11 check the C/N operation.

Steps 12 and 13 check the C/N ratio accuracy and gives a qualitative display of the C/N ratio on a spectrum analyser.

TEST EQUIPMENT

Synthesiser.....	HP 3335A
Spectrum Analyser.....	HP 8568A
Power Meter.....	HP 436A

1. Connect the 0dBm REF OUTPUT to the 3708A POWER METER input using the cable supplied and select the 70MHz reference tone. In the Power Meter mode press SHIFT, POWER METER ZERO. The 3708A Power Meter should read $0.00\text{dBm} \pm 0.02\text{dB}$.
2. Set the Synthesiser to 70MHz at 0dBm and connect it to the 3708A POWER METER input. The 3708A Power Meter should read $0.0\text{dBm} \pm 0.3\text{dB}$, if this is not the case verify the Synthesiser and 0dBm REF OUTPUT levels using a suitable calibrated power meter.
3. Set the Synthesiser to various levels from +5dBm to -35dBm and check that the 3708A Power Meter reading and Synthesiser output level track each other within $\pm 0.3\text{dB}$. Reduce the Synthesiser output level to -45dBm and check that the 3708A Power Meter reading and Synthesiser output level track each other within 0.5dB.
4. Repeat step 1 to re-zero the Power Meter.
5. Connect the 3708A NOISE OUTPUT to the test equipment Power Meter. Select NOISE GEN N, 70 \pm 5MHz at 0dBm and check that the Power Meter reads $0.0\text{dBm} \pm 0.25\text{dB}$. Repeat the above for each internal NOISE BAND filter.

6. Connect the 3708A NOISE OUTPUT to the input of the Spectrum Analyser ensuring the correct impedance match. Select Noise at 0dBm using the 70 ± 5 MHz filter. On the Spectrum Analyser adjust the Centre Frequency, Frequency Span and Reference Level to give a display near the top of the display screen. Use the Video Bandwidth control to remove the noise on the display and then note the level at the filter centre frequency, use the MARKER facility on the Spectrum Analyser if available.

NOTE: The noise power displayed will NOT be on the 0dBm reference line on the spectrum analyser. It is the accumulative noise power in the NOISE BAND selected that equates to 0dBm.

7. Reduce the 3708A NOISE OUTPUT in steps to -40dBm and ensure that the Spectrum Analyser display follows the noise level ± 2 dB.
8. Repeat steps 6 and 7 for the other NOISE BAND filters.
9. Connect the 0dBm REF OUTPUT to the IF INPUT using the short cable supplied. Select C/N, at 0dB, with the 70 ± 5 MHz filter (press C/N, 0, ENTER, 70 ± 5). Connect the IF OUTPUT to the test equipment Power Meter and switch the Noise OFF. The Power Meter should read $0.0\text{dBm} \pm 0.5\text{dB}$.
10. Switch the Noise ON and select TRACK INHIBIT. Remove the signal from the IF INPUT. The Power Meter should read $0.0\text{dBm} \pm 0.7\text{dB}$.
11. Deselect the TRACK INHIBIT and repeat steps 9 and 10 for the other NOISE BAND filters.
12. Set the Synthesiser to 0dBm at 70MHz and connect it to the IF INPUT. Select C/N, at 10dB, with the 70 ± 5 MHz filter (press C/N, 10, ENTER, 70 ± 5). Connect the IF OUTPUT to the Spectrum Analyser input and adjust the Spectrum Analyser to display the carrier, at 70MHz and the generated noise.

NOTE: The spectrum analyser will NOT display a noise level exactly 10dB below the carrier but will display a noise band whose accumulative power equates to a C/N ratio of 10dB.

13. Vary the output level of the Synthesiser ± 5 dB and check on the Spectrum Analyser display that the Carrier to Noise ratio remains at the figure noted in step 12 ie the noise level tracks the carrier level.



OPERATING MANUAL

3708A NOISE AND INTERFERENCE TEST SET

(Including Option 001)

SERIAL NUMBERS

This manual applies directly to instruments with serial numbers prefixed 2414U.

For additional important information about serial numbers, see INSTRUMENTS COVERED BY MANUAL in Section 7.

© Copyright HEWLETT-PACKARD LIMITED 1984
SOUTH QUEENSFERRY, WEST LOTHIAN, SCOTLAND

Manual Part Number: 03708-90001
Microfiche Part Number: 03708-90026

Printed: August 1984

WARNING

READ THE FOLLOWING NOTES BEFORE INSTALLING OR SERVICING THE INSTRUMENT.

1. IF THIS INSTRUMENT IS TO BE ENERGIZED VIA AN AUTO-TRANSFORMER MAKE SURE THAT THE COMMON TERMINAL OF THE AUTO-TRANSFORMER IS CONNECTED TO THE NEUTRAL POLE OF THE POWER SOURCE.
2. THE INSTRUMENT MUST ONLY BE USED WITH THE MAINS CABLE PROVIDED. IF THIS IS NOT SUITABLE, CONTACT YOUR NEAREST HP SERVICE OFFICE. THE MAINS PLUG SHALL ONLY BE INSERTED IN A SOCKET OUTLET PROVIDED WITH A PROTECTIVE EARTH CONTACT. THE PROTECTIVE ACTION MUST NOT BE NEGATED BY THE USE OF AN EXTENSION CORD (POWER CABLE) WITHOUT A PROTECTIVE CONDUCTOR (GROUNDING).
3. THE SERVICE INFORMATION FOUND IN THIS MANUAL IS OFTEN USED WITH POWER SUPPLIED TO AND PROTECTIVE COVERS REMOVED FROM THE INSTRUMENT. ENERGY AVAILABLE AT MANY POINTS MAY, IF CONTACTED, RESULT IN PERSONAL INJURY.
4. BEFORE SWITCHING ON THIS INSTRUMENT:
 - (a) Make sure the instrument input voltage selector is set to the voltage of the power source.
 - (b) Ensure that all devices connected to this instrument are connected to the protective (earth) ground.
 - (c) Ensure that the line power (mains) plug is connected to a three-conductor line power outlet that has a protective (earth) ground. (Grounding one conductor of a two-conductor outlet is not sufficient).
 - (d) Check that the instrument fuse(s) is of the correct type and rating.
5. SERVICING INFORMATION:
 - (a) This manual contains information, cautions, and warnings which must be followed to ensure safe operation and to retain the instrument in safe condition. Service and adjustments should be performed only by qualified service personnel.
 - (b) Any adjustment, maintenance, and repair of the opened instrument under voltage should be avoided as much as possible and, when inevitable, should be carried out only by a skilled person who is aware of the hazard involved.
 - (c) Capacitors inside the instrument may still be charged even if the instrument has been disconnected from its source of supply.
 - (d) Whenever it is likely that the protection has been impaired, the instrument must be made inoperative and be secured against any unintended operation.

USING THIS MANUAL

The aim of this manual is to inform the user of the operating functions related to the 3708A in an easy to understand manner. To help the user a breakdown of the 3708A manual is outlined below.

- 1** **What is the HP 3708A?** - This section describes the HP 3708A and its uses (*see Page 1*).

- 2** **Front and Rear Panel Features** - All front and rear panel keys, displays and connectors are identified (*see Page 3*).

- 3** **Principle Measurement Modes and Built-in Features** - An explanation of each of the principle measurement modes and built-in features are given in this section (*see Page 17*).

- 4** **Quick Measurement Settings** - Step by step examples of how to use each feature (*see Page 37*).

- 5** **Operator's Checks** - Simple procedures designed to verify that the main functions of the HP 3708A operate properly (*see Page 43*).

- 6** **HP-IB** - The Hewlett-Packard Interface Bus section contains general HP-IB information, a summary of HP-IB capabilities and a list of program codes. Examples of sub-routines are also contained in this section (*see Page 45*).

- 7** **General Information** - This information which includes the instrument specification is also contained in Section I of the service manual (*page 69*).

- 8** **Installation** - This information contains installation instructions for the 3708A and is also contained in Section II of the service manual (*see Page 75*).

LIST OF CONTENTS

1 WHAT IS THE 3708A?

What is the HP 3708A?	Page 1
Where is the HP 3708A Used?	1

Figure

1-1 3708A Simplified Block Diagram	Page 1
1-2 Using the 3708A in a Radio System	1

2 FRONT AND REAR PANEL FEATURES

Front Panel Keyboard	Page 3
MODE keys	5 to 7
DATA ENTRY keys	8
NOISE BW keys	9
NOISE BAND keys	10
EXT FILTER Keys	12

Front Panel Display	Page 13
-------------------------------	---------

Rear Panel Switches and Connectors	Page 15
--	---------

Figure

2-1 3708A Front Panel	Page 2
2-2 Front Panel Keyboard	3
2-3 Front Panel Display	13
2-4 Rear Panel Switches and Connectors	15

3 PRINCIPLE MEASUREMENT MODES AND BUILT-IN FEATURES

Built-in Features

0dBm REFERENCE SOURCE	Page 18
Common Uses for the 0dBm REFERENCE SOURCE	18

Calibration Cycle	18
Inhibiting the Calibration Cycle	18

Principle Measurement Modes

POWER METER	Page 19
Using the POWER METER	19

Averaging	20
Power Meter Zero Calibration	20
NOISE GENERATOR	Page 21
Calibration Cycle	21
Generating NOISE POWER (N)	22
Using the NOISE DENSITY (No) mode	22
Selecting a NOISE BAND Filter	22
Using an EXTERNAL Filter	23
Disabling the NOISE OUTPUT	24
NOISE BW (bandwidth) MEASUREMENT AND INSERTION LOSS	25
INSERTION LOSS	25
Making an Insertion Loss Measurement	25
NOISE BW (bandwidth)	26
Making a NOISE BW (bandwidth) Measurement	27

CARRIER + NOISE and/or INTERFERENCE MIXER	Page 29
CARRIER TO NOISE MEASUREMENT MODES	29
Making a C/N (Carrier to Noise) Measurement	30
Additional Features Available in the C/N Mode	31
Making a C/No (Carrier to Noise Density) Measurement	32
Additional Features in the C/No Mode	32
Making an Eb/No (Energy per Bit to Noise Density) Measurement	33
Additional Feature in the Eb/No Mode	33
CARRIER TO NOISE WITH INTERFERER TONE MEASUREMENT MODE	34
CARRIER TO INTERFERENCE MEASUREMENT MODE	34
Making a C/I (Carrier to Interference) Measurement	34

Available Features

Tracking	Page 36
Track Inhibit	36
Enter Carrier Power/Cancel	36

Figure

3-1 Noise Generator	Page 21
3-2 Noise Bandwidth to Insertion Loss/Gain Ratio	23
3-3 Insertion Loss Set-up	25
3-4 Noise Bandwidth Set-up	27
3-5 Signal Paths Used in Carrier/Noise Measurements	28
3-6 Using the 3708A in a Radio Receiver	30

4 QUICK MEASUREMENT SETTINGS

Calibrating the POWER METER	Page 37
Making a Power Measurement	37
Using the AVERAGE N Feature of the POWER METER Mode	37
Generating NOISE POWER	38
Generating Noise Defined as a NOISE DENSITY	38
Selecting a NOISE BAND using Internal Filters	38

Selecting a NOISE BAND using External Filters	38
Entering the NOISE BANDWIDTH of an External System	39
Setting a CARRIER to NOISE Ratio	40
Setting a CARRIER to NOISE DENSITY Ratio	40
Setting an ENERGY PER BIT to NOISE DENSITY Ratio	40
Setting a CARRIER to INTERFERENCE Ratio	40
Measuring CARRIER POWER at the IF INPUT	41
Displaying Generated Noise or Interference at the IF OUTPUT	41
Measuring NOISE BW (bandwidth)	41
Measuring Insertion Loss	42
Entering Insertion Loss	42
INSTRUMENT DEFAULT PARAMETERS	42

Table

4-1 3708A Default Parameters	Page 42
--	---------

5 OPERATOR'S CHECKS

Operator's Checks	Page 43
-----------------------------	---------

6 HEWLETT-PACKARD INTERFACE (HP-IB)

Introduction	Page 46
Operating Distances	46
HP-IB Capability	47
Addressing the 3708A	47
HP-IB Address Switch	49
Remote Operation of the 3708A	49
Message Format	50
Reading Data from the 3708A (-ASCII mode)	50
Simple Programs for Reading Data from the 3708A	52
Binary Mode	53
3708A Status Request Codes	53
The 3708A Requesting Service (SRQ)	54
Status Bytes	54
SRQ Mask	55
SRQ On/Off	55
HP-IB Universal Commands	56
The 3708A Data Message Commands	59
Sample Program	66

Figure

6-1 Address Switch	Page 49
6-2 Basic Operation - HP-IB Codes	68

Table

6-1 HP-IB Capability	Page 47
6-2 HP-IB Addresses	48
6-3 HP-IB Measurements Codes	51

6-4	Status Byte Description	54
6-5	Instrument Parameter Default Settings	56
6-6	3708A Data Message Commands (Key Action)	59
6-7	3708A Message Commands (Functional)	62

7 GENERAL INFORMATION

Introduction	Page 69
Specification	69
Safety Consideration	69
Instruments Covered by Manual	69
Description	70
Accessories Supplied	70
Options	70

Table

7-1	Specifications	Page 71
-----	--------------------------	---------

8 INSTALLATION

Introduction	Page 75
Initial Inspection	75
Preparation for Use	75
Power Requirements	76
Line Voltage Selection and Fuses	76
Power Cable	76
Operating Environment	77
Rack Mounting	77
Storage and Shipment	78
HEWLETT-PACKARD INTERFACE BUS (HP-IB) INSTALLATION	79
Connection to HP-IB	79
HP-IB Cables	79
HP-IB Address Switch	80

Figure

8-1	Power Receptacles	Page 77
8-2	HP-IB (rear panel) Connector	79
8-3	Address Switch	80

Table

8-1	Fuses	Page 76
8-2	HP-IB Interface Cables	79
8-3	HP-IB Addresses	81

APPENDIX A

System Bandwidth Page 83

APPENDIX B

Self Test Page 85

APPENDIX C

Self Test Error Codes Page 87

INDEX Page 89

2 FRONT AND REAR PANEL FEATURES

The aim of this section is front and rear panel familiarisation. Contained in the following pages are illustrations and descriptions of all front and rear panel keys and connectors. The information is organised into three main sections.

- ★ Front Panel Keyboard
- ★ Front Panel Display
- ★ Rear Panel Switches and Connectors

★ FRONT PANEL KEYBOARD

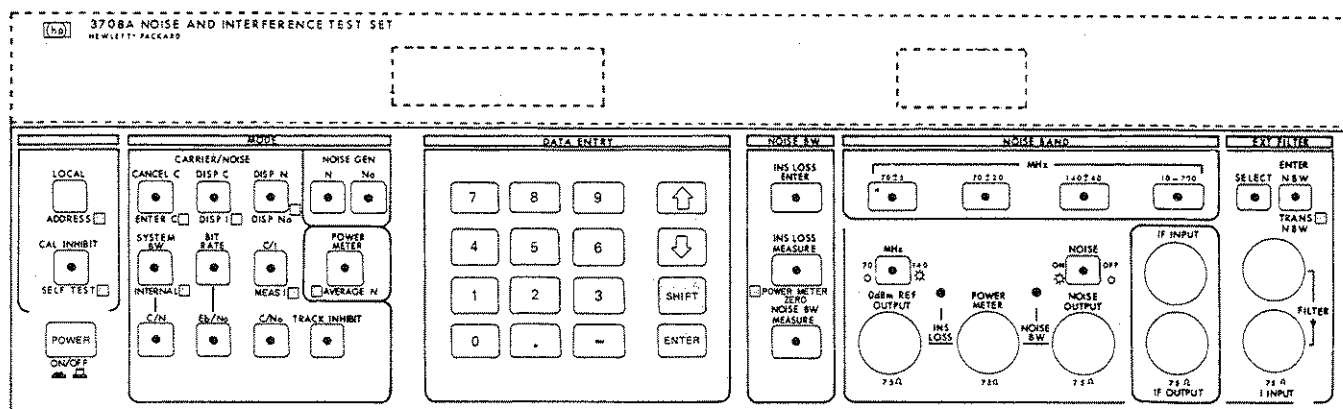

Figure 2-2 Front Panel Keyboard

All front panel keys and displays are numbered in Figure 2-1. The keyboard is made up of the main functional areas listed below, also see Figure 2-2.

MISC KEYS	<i>Page 4</i>	NOISE BW	<i>Page 9</i>
MODE	<i>Pages 5,6 & 7</i>	NOISE BAND	<i>Pages 10 & 11</i>
DATA ENTRY	<i>Page 8</i>	EXT FILTER	<i>Page 12</i>

The key information in this section of the manual is organised in a similar manner to the front keyboard. Each key is identified by:

- a number (obtained from Figure 2-1)
- an illustration
- a functional description

◀ Figure 2-1 3708A Front Panel

POWER/ON, LOCAL/ADDRESS & CAL INHIBIT/SELF TEST KEYS

★ Some front panel keys are dual function keys. The functions shown thus "■" (printed in blue on the front panel) are selected by first pressing the blue SHIFT key.

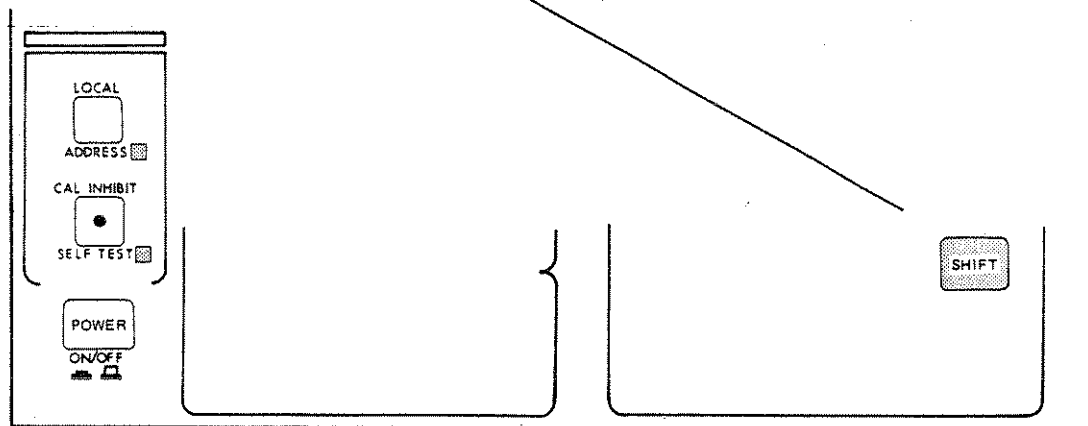

- 1 **LOCAL** - This key returns the 3708A from the REMOTE HP-IB control to the LOCAL (FRONT PANEL) operation - only if LOCAL LOCKOUT (LLO) is not in operation.
- **ADDRESS** - If the SHIFT KEY is pressed previous to the ADDRESS key then the instrument HP-IB address is displayed momentarily. *The instrument monitors the address switch setting ONLY at switch on, therefore the displayed address is read from the instrument memory, not the switch. If the address has been changed since switch on, the new address will not be displayed until the instrument has been switched OFF and then ON.*
- 2 **CAL INHIBIT** - When this key is pressed the LED in the centre of the key illuminates and the 3708A self-calibration cycle is inhibited.
- **SELF TEST** - This key is used in conjunction with the SHIFT key and keys 0, 1, 2 and 3 to initiate self test routines which verify a large part of the instruments operation. Details of these self tests are contained in Appendix B and in the troubleshooting contained in the service manual.
- 3 **POWER** - This is used to switch the power ON or OFF.

MODE

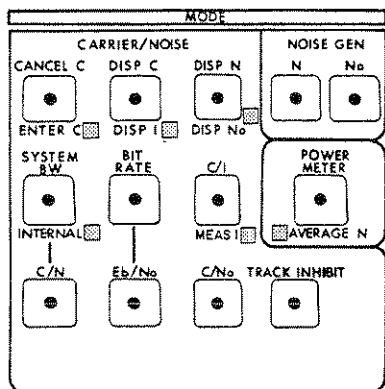

There are three main operating modes in this section:

- CARRIER/NOISE
- NOISE GENERATOR
- POWER METER

The key function associated with each mode of operation is discussed in the following sections.

CARRIER/NOISE Mode

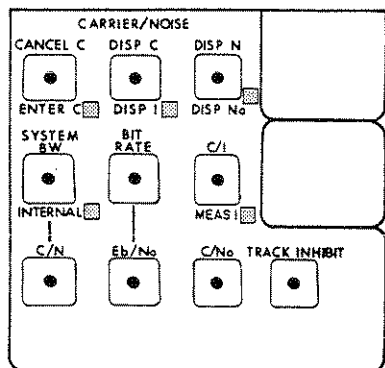

★ Some front panel keys are dual function keys. The functions shown thus "■" (printed in blue on the front panel) are selected by first pressing the blue SHIFT key.



- 4 ■ ENTER C - This key, used in conjunction with the SHIFT key, allows a carrier power to be entered when it cannot be measured successfully with the power meter.

CANCEL C - This cancels the carrier power value entered in the ENTER C mode. The instrument returns to its normal mode of operation (and uses the measured value of carrier level for computations of Carrier to Noise ratios.)

- 5 SYSTEM BW - This key (in conjunction with the numeric keys and the ENTER key) allows the user to enter the noise bandwidth of the radio system (or item under test). The noise generated is now automatically adjusted to define the carrier to noise ratio with respect to the system bandwidth entered.

- INTERNAL - Used with the SHIFT key, the Noise Bandwidth (NBW) of the 3708A is now determined by the internal Noise Band filter selected.

MODE

- 6 **C/N** - This key allows the C/N ratio to be entered using the numeric keys followed by the ENTER key.
- 7 **DISP C** - This displays the Carrier Power present at the front panel, or the carrier level entered (as in ENTER C).
 - ▣ **DISP I** - Used with the SHIFT key, the Interference Power at the IF OUTPUT is displayed, (this key sequence is only valid when the instrument is in the C/I mode of operation).
- 8 **BIT RATE** - In order to calculate the Eb/No ratio the Bit Rate of the system is required. This information is entered using the BIT RATE key and the numeric keys. This key is only valid in the tracking mode.
- 9 **Eb/No** - This key displays the ratio of the Energy per Bit to Noise Spectral Density, on the front panel display. This is a definition of the noise density but is only relevant in the tracking mode.
- 10 **DISP N** - This allows the user to view the generated noise power as it tracks carrier power variations, maintaining a constant C/N ratio.
 - ▣ **DISP No** - Used with the SHIFT key, this allows the user to view the generated spectral Noise Density as it tracks carrier power variations, maintaining a constant C/No ratio.
- 11 **C/I** - This key allows the Carrier/Interference ratio to be entered using the numeric keys followed by the ENTER key.
 - ▣ **MEAS I** - When preceded by the SHIFT key, the Interference power at the I INPUT is measured and the I LEVEL annunciators indicate whether the signal is too high, too low or suitable.
- 12 **C/No** - This key allows the Carrier/Noise Density ratio to be entered using the numeric keys followed by the ENTER key.
- 13 **TRACK INHIBIT** - This key disables the tracking facility in the 3708A, and the noise or interference tone (whichever ratio measurement is selected) remains constant. To restore the tracking facility, simply press the key again.

MODE

NOISE GENERATOR mode

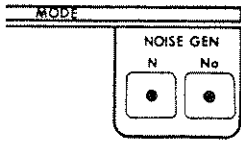

- 14 N - Pressing this key causes the instrument to enter the Noise Generator mode (if it is not already in this mode) and display the value of noise power level. This can be altered as required by keying in a new value using the numeric keys followed by the ENTER key.
- 15 No - Pressing this key causes the instrument to enter the Noise Generator mode (if it is not already in this mode) and display the equivalent value of Noise Power Density. This value of Noise Density can be altered using the numeric and ENTER keys.

NOTE: The accuracy of Noise Generation is degraded if the POWER METER ZERO function is used to normalise the effect of a lossy cable.

For accurate Noise Generation the POWER METER ZERO calibration must be made with a short, low loss cable(see key 25 in NOISE BW section).

POWER METER mode

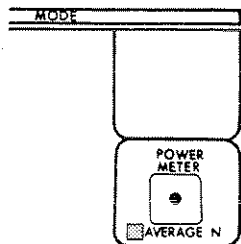

★ Some front panel keys are dual function keys. The function shown thus "■" (printed in blue on the front panel) is selected by first pressing the blue SHIFT key.



- 16 **POWER METER** - This key selects the Power Meter measurement mode of the instrument. The 3708A can now measure power levels from +5dBm to -45dBm in the frequency range 10MHz to 200MHz.
- **AVERAGE N** - Used in conjunction with the SHIFT key, it integrates the number of power measurements taken and the average reading is displayed. The number of readings per measurement can be varied from 0 to 200 using the numeric and ENTER keys. (Note: the instrument defaults to average 10 at switch on).

DATA ENTRY

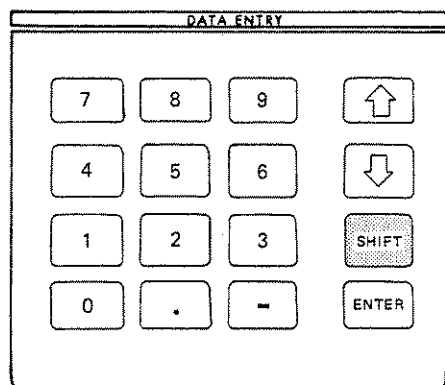

The keys associated with entering data into the instrument may be split into two sections.

- numeric keys
- keys associated with entering/ changing numeric data





- 17 Although the blue **SHIFT** key is located in the **DATA ENTRY** block its function is **NOT** associated with entering data. The **SHIFT** key selects the secondary functions marked in blue on the front panel.

Numeric Keys

- 18 **0,1,2,3,4,5,6,7,8,9** (Numeric Keys) - These keys are used to specify parameter settings in the various modes of operation.
- 19 **Decimal point** - The decimal point is used in conjunction with the numeric keys.
- 20 **Minus** - The minus sign allows negative values to be entered.

Keys Associated with Entering/Changing Numeric Data

- 21 **ENTER** - This key is used to enter numeric data in the various operating modes and must be pressed each time data is changed or entered.
- 22  - This key allows the user to decrement the data entered.
- 23  - This key allows the user to increment the data entered.

NOISE BW

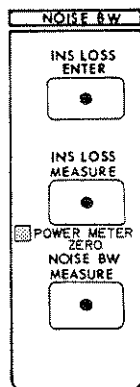

The three NOISE BW (bandwidth) keys are used for noise bandwidth measurements on radio frequency (rf) filters.

★Some front panel keys are dual function keys. The function shown thus "■" (printed in blue on the front panel) is selected by first pressing the blue SHIFT key.



- 24 **INS LOSS ENTER** - This key is used in Noise Bandwidth measurements. The insertion loss of an external filter can be entered directly by keying INS LOSS ENTER, the insertion loss (in dB), followed by ENTER.
- 25 **INS LOSS MEASURE** - This key is mainly used in Noise Bandwidth measurements when the insertion loss of a filter is unknown. To measure the insertion loss, connect the filter (or item under test) between the 0dBm REF OUTPUT and the POWER METER input connectors. Press INS LOSS MEASURE - the insertion loss of the filter is now displayed and stored in memory avoiding the need to enter the insertion loss.
- **POWER METER ZERO** - This key allows cable losses to be equalized out prior to measurements. (To zero the power meter, connect the 0dBm REF OUTPUT to the POWER METER input and press SHIFT, POWER METER ZERO.)
- 26 **NOISE BW MEASURE** - Pressing this key forces the 3708A to make a Noise Bandwidth measurement of an item under test (usually a filter) connected between the NOISE OUTPUT and the POWER METER input. The result is displayed in the right hand display. [Note: Prior to making Noise Bandwidth measurements, the insertion loss of the device must first be measured or entered.]

NOISE BAND

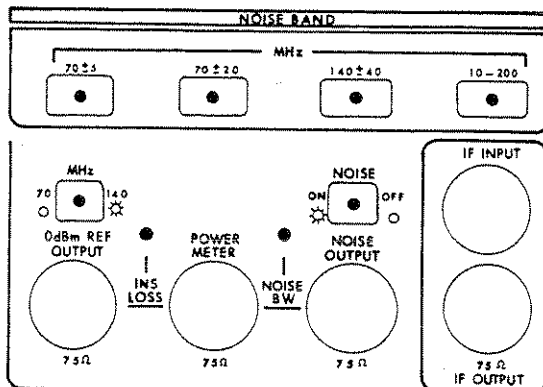

- 27 70±5
- 28 70±20
- 29 140±40
- 30 10-200

These are the NOISE BAND (in MHz) select keys. Each key selects a band pass filter in the frequency range marked. The filter determines the width of the noise slot.

- 31 **70/140** - The reference tone output can be selected to be either 70MHz or 140MHz.
- 32 **NOISE ON/OFF** - This switches the Noise Generator off resulting in no noise at either the NOISE OUTPUT or IF OUTPUT. *Note: In the C/I mode, no interference tone (from the front panel I INPUT) is present at the IF OUTPUT when the NOISE ON/OFF switch is OFF.*
- 33 **0dBm REF OUTPUT** - This provides an accurate reference level output at 0dBm with a choice of frequency at either 70MHz or 140MHz.
- 34 **POWER METER** - This is the input port for the power meter measurements.

NOISE BAND

- 35 **NOISE OUTPUT** - This provides noise in the selected noise band.
- 36 **INS LOSS** - This indicator is on when the insertion loss is being measured.
- 37 **NOISE BW** - This indicator is on when the NOISE BANDWIDTH is being measured.
- 38 **IF INPUT** - This is the input port for the IF carrier signal.
- 39 **IF OUTPUT** - This is the main output on the 3708A providing the various combinations of outputs (Carrier to Noise and/or Interference tone) as selected by the front panel controls.

EXT FILTER

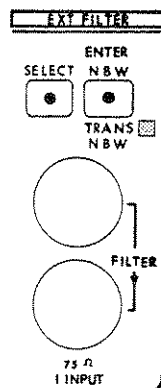

★ Some front panel keys are dual function keys. The function shown thus "■" (printed in blue on the front panel) is selected by first pressing the blue SHIFT key.



- 40 **SELECT** - This is used to select an external filter connected across the **FILTER** ports.
- 41 **ENTER N BW** - This key is used in conjunction with the numeric keys to enter the noise bandwidth of the external filter connected across the **FILTER** ports. *(To measure noise bandwidth - see page 24).*
- **TRANS N BW** - This facility is particularly useful when an external filter of unknown Noise Bandwidth is being used. In such cases the Noise Bandwidth of the filter has to be measured *(as outlined in Page 28)*. After the measurement, the noise bandwidth of the filter can be entered into memory, simply by pressing **SHIFT, TRANS N BW**. This avoids the need to use the **ENTER N BW** key.



- 42 **FILTER PORTS** - The **FILTER** ports allow an external filter to be connected when the noise band requirements are not met by the internal noise band filters. This filter is selected by pressing the **SELECT** key.

43*

- 43 **I INPUT** - This is the interference tone input (marked in green on the front panel) - selected by the **C/I** key.

*NOTE: The lower **FILTER PORT** also serves as the **I INPUT**.

★ FRONT PANEL DISPLAY

The front panel numeric readouts and annunciators (shown in Figure 2-3) are highlighted in this section of the manual.

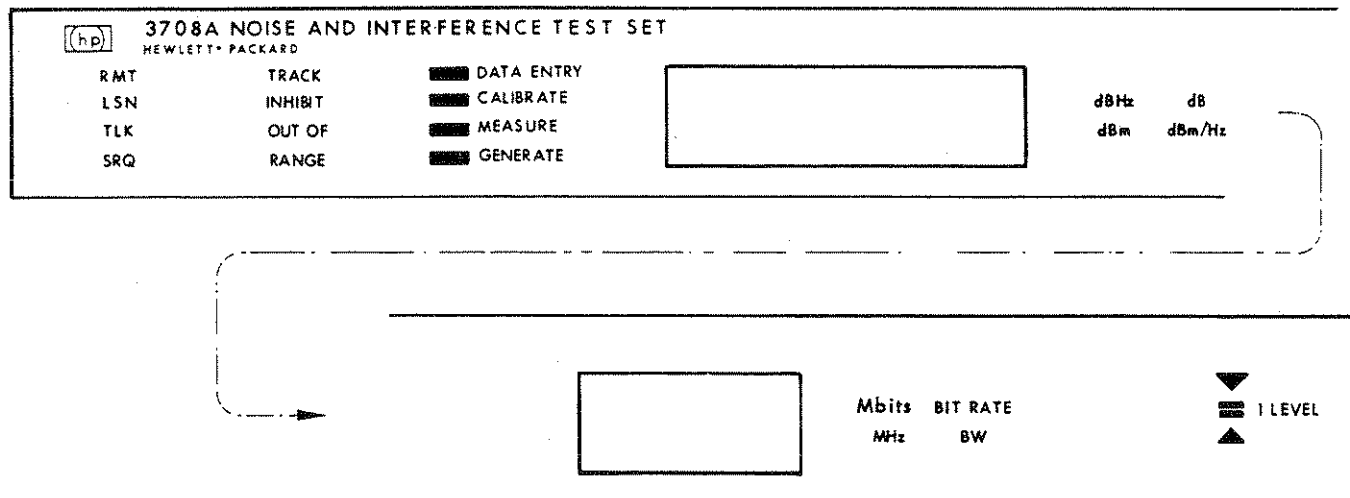



Figure 2-3 Front Panel Display

- | | |
|------------------------------------|---|
| <p>RMT
LSN
TLK
SRQ</p> | <p>44 These are indicators for the HP-IB operational mode, REMOTE, LISTEN, TALK and SRQ.</p> |
| <p>TRACK
INHIBIT</p> | <p>45 TRACK INHIBIT - This indicator is on when the TRACK INHIBIT key is pressed. It is also on when the 3708A is unable to track because the carrier amplitude is either too large or too small or when the ENTER C facility is being used.</p> |
| <p>OUT OF
RANGE</p> | <p>46 OUT OF RANGE - This indicates that the noise or interference required (to maintain the C/N or C/I ratio) is outwith the range of the 3708A, reducing the accuracy of the IF OUTPUT ratio.</p> |
| <p>DATA ENTRY</p> | <p>47 DATA ENTRY - This indicator is on when data is being entered. If an invalid entry is made this indicator flashes off and on. If the entry is valid then the indicator switches off.</p> |
| <p>CALIBRATE</p> | <p>48 CALIBRATE - This indicator is on when the 3708A performs a calibration cycle, all measurements are halted momentarily during the calibration cycle.</p> |

 MEASURE

49 **MEASURE** - This on when the 3708A is making a measurement.

 GENERATE

50 **GENERATE** - This indicator is on when the instrument is generating noise.



51 **DISPLAY** - Used to indicate the values of the measured data.

dBHz dB
dBm dBm/Hz

52 **dBHz dB** - Indicates the units of the displayed data.
dBm dBm/Hz





53 **DISPLAY** - This display is used to indicate the values of either the Bit Rate or the Noise Bandwidth.

Mbits BIT RATE
MHz BW

54 **Mbit/s BIT RATE** - Indicates the units in which the BIT RATE is displayed.

MHz BW - This indicates the units in which the Bandwidth is displayed.

 I LEVEL

55 **I LEVEL** - These indicate when the Interference signal is of a suitable level,  is illuminated when it is too high,  when it is too low, and  when it is suitable. When an EXT FILTER is connected it indicates the suitability of the insertion loss of the filter.

★ REAR PANEL Switches and Connectors

All rear panel features are described in this section of the manual.

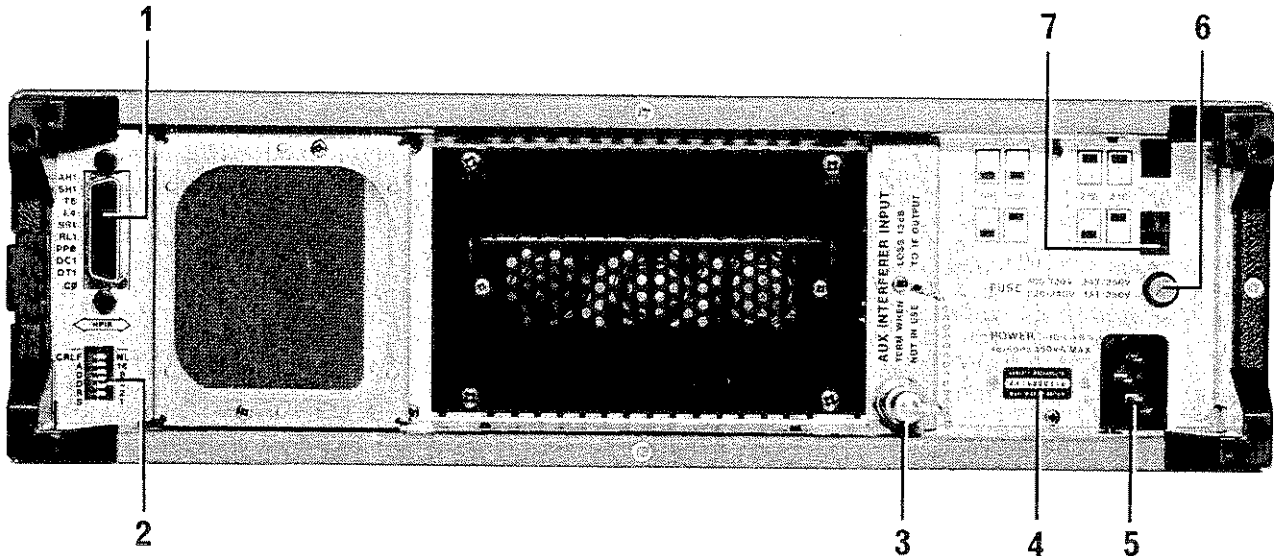

Figure 2-4 Rear Panel Switches and Connectors

1. **HP-IB Connector** - A 24 pin female connector, used to connect the 3708A to the Hewlett-Packard Interface Bus for remote operation. Connection information is presented in Section 8, Installation.
2. **HP-IB Switch** - The HP-IB address is set by the dual in line ADDRESS switch.
3. **AUXiliary INTERFERER INPUT** - This broadband input allows a single tone to be injected via a fixed 15dB loss path to the IF OUTPUT port. This facility allows an external interferer to be mixed with the carrier signal and the generated noise.
4. **Serial Number Plate** - The first four digits and the letter constitute the prefix which defines the instrument configuration. The last five digits form a sequential suffix that is unique to each instrument.
5. **Line Power Input Connector** - Accepts line power supplies of 100, 120, 220 or 240V ac +5%-10%, as selected with the line voltage selector, in the frequency range 48 to 66Hz.
6. **Fuse** - The line fuse should be of the correct value for the line voltage selected. Fuse selection is described in Section 8, Installation.

7. **Line Voltage Selector** - These two switches are used to select the line voltage. The rear panel is marked with voltage selection information indicating the required positions for the switches for the different voltages.

3 PRINCIPLE MEASUREMENT MODES AND BUILT-IN FEATURES

The 3708A measurement modes and built-in features are explained in this section of the manual. The information is given in the order shown below.

- BUILT-IN FEATURES
- PRINCIPLE MEASUREMENT MODES

The main topics covered in each sub-section are highlighted here.

Built-in Features

★ 0dBm Reference Source	Page 18
★ Calibration Cycle	18

Principle Measurement Modes

★ Power Meter	Page 19
★ Noise Generator	21
★ Noise Bandwidth Measurement and Insertion Loss	25

Carrier + Noise and/or
Interference Mixer

★ Carrier + Noise	29
- Noise Tracking	
- Noise Non-Tracking	
★ Carrier + Noise + Interference	34
- Noise Tracking	
- Noise Non-Tracking	
★ Carrier + Interference	34
- Interference Tracking	
- Interference Non-Tracking	

BUILT-IN FEATURES

★ 0dBm REFERENCE SOURCE

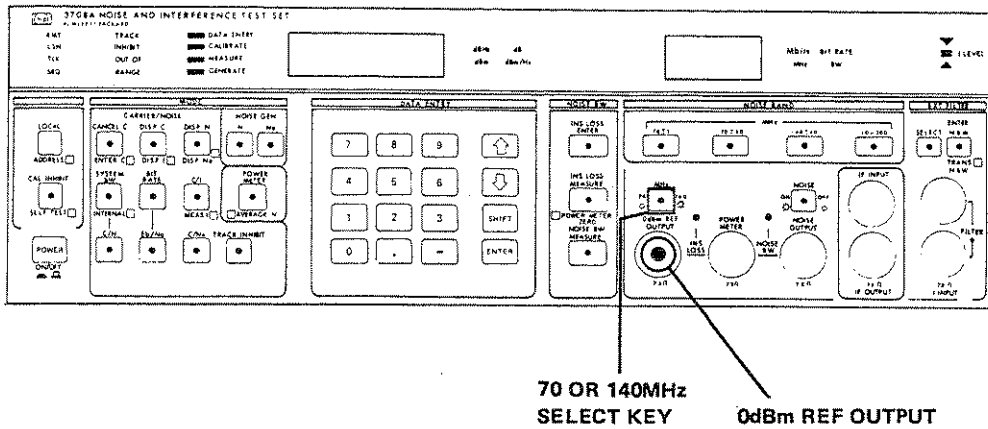

The 3708A produces 0dBm at the 0dBm REF OUTPUT port on the front panel. The frequency of the 0dBm signal can be switched between 70MHz or 140MHz by using the 70/140MHz key.

Common Uses for the 0dBm REFERENCE SOURCE

1. To zero the power meter
2. As a source of Interference
3. As a general purpose, fixed level and fixed frequency source.

★ CALIBRATION CYCLE

The 3708A calibration cycle calibrates the various signal paths throughout the instrument. The calibration can be initiated by a change of mode, or internal filter or by a temperature change, which can be detected by either of the internal temperature sensors. One of the sensors is located in the Power Meter section of the 3708A and the other in the Noise Generator section. The cycle lasts approximately 2-3 seconds, during which time the CALIBRATE indicator is illuminated on the front panel.

Inhibiting the Calibration Cycle

The 3708A provides the facility to inhibit calibrations due to temperature changes, which is useful during long term testing when no interruptions are desired. To use this facility, press the CAL INHIBIT key. The LED in the key lights to indicate that the calibrations are inhibited. To exit this facility press the CAL INHIBIT key again, the LED extinguishes and the 3708A resumes calibrations when necessary.

PRINCIPLE MEASUREMENT MODES

There are four main operating modes (see list on page 17) in the 3708A, an in depth account of each is given in the following paragraphs.

★ POWER METER

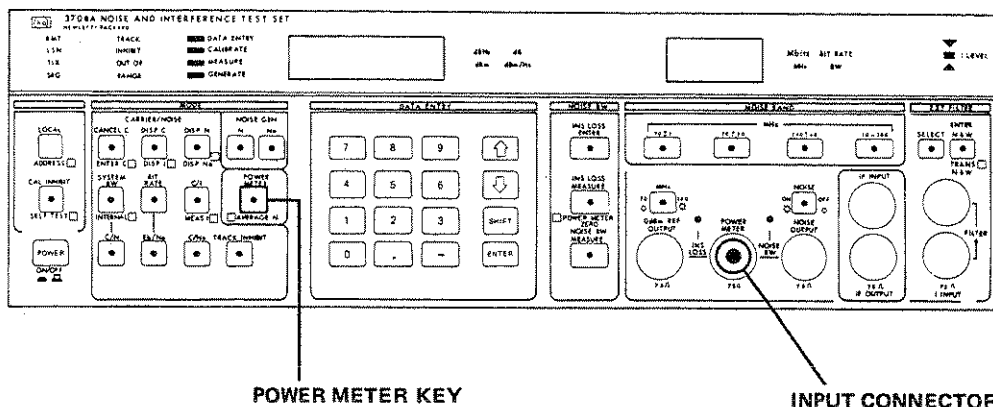

Introduction

The POWER METER mode of operation allows the 3708A to make accurate power measurements of signal levels present at the POWER METER input.

Range

The power meter gives an accurate result (usually within 0.1dB - see specifications, Table 7-1) over the frequency range 10 to 180MHz of levels between +5dBm and -45dBm.

Using the POWER METER

To make a power measurement:

1. Press the POWER METER key.
2. If necessary, calibrate the power meter by linking the 0dBm REF OUTPUT to the POWER METER input. Press SHIFT, POWER METER ZERO to equalise for the cable losses and bring the power meter reading to zero.
3. The instrument is now ready to measure power levels at the POWER METER input. The averaging can be changed as desired to alter the speed and readability of the measurements, as described below.

NOTE: During warm-up (approximately 10-30 minutes) it is recommended that the Power Meter is calibrated before each power measurement. Thereafter calibration should be carried out at periodic intervals or before a high accuracy power reading is required.

Averaging

A software averaging constant (N) is used to provide a selection of integration times and measurement speeds. When measuring power levels of signals with low frequency noise components, the averaging used in the display algorithm may be increased to give a flicker free display. The averaging constant selected can be between 0 and 200. The longer the averaging the slower the display will react to amplitude changes, therefore a compromise may have to be made in order to track changes in power levels.

An "AVERAGE N" constant of 20 can be entered in the following way.

Press SHIFT, AVERAGE N, 20, ENTER.

The 3708A will calculate the power and display it using the algorithm.

$$\text{New Display} = (\text{N} \times \text{Current Display} + \text{RMS value}) / (\text{N} + 1)$$

At switch on the "AVERAGE N" constant is always set to 10.

Power Meter Zero Calibration

The power meter can be calibrated using the 0dBm reference signal, ie,

1. Press the POWER METER key, to select the power meter mode.
2. Link the 0dBm REF OUTPUT to the POWER METER input.
3. Press SHIFT, POWER METER ZERO.

The 3708A measures the power at the POWER METER input and generates a correction factor to make the display read 0.00dBm. Provided the same cable is used for subsequent Power measurements the results are referenced to the accuracy of the 0dBm REF OUTPUT, and the cable loss is taken into account.

★ NOISE GENERATOR

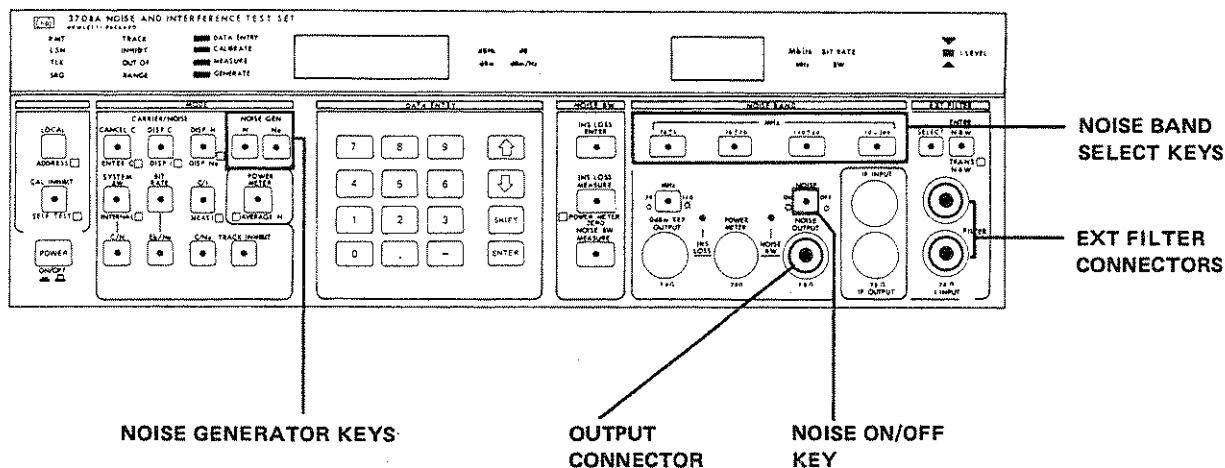

Introduction

The 3708A can be used as a stand alone Noise Generator. The Noise Generator is made up of a noise source and four internal NOISE BAND filters (see Figure 3-1). A Noise Power (N) output in the range 5.9dBm to -86.8dBm or Noise Density in dBm per Hz can be obtained. Provision is made for the connection of external filters via the EXT FILTER input for noise band requirements NOT covered by the NOISE BAND filters of the instrument.

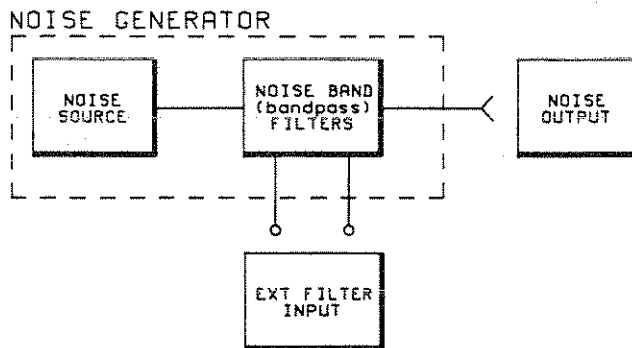

Figure 3-1 Noise Generator

Calibration Cycle

The Noise Generator level accuracy may be affected by temperature changes. The 3708A overcomes this problem by initiating a calibration cycle. This automatically occurs during instrument warm-up or when the ambient temperature changes by 5 degrees C or more.

The automatic calibration cycle can be inhibited by pressing the CAL INHIBIT key. This facility is useful during long term testing where interruptions are undesirable. *More details on the calibration cycle are given on Page 18.*

Generating NOISE POWER (N)

Power levels in the range +5.9dBm to -86.8dBm may be obtained at the NOISE OUTPUT. The following procedure illustrates how an operator selects a NOISE POWER(N) of -20dBm.

1. Calibrate the Power Meter by pressing POWER METER to select the power meter mode and linking the 0dBm REF OUTPUT to the POWER METER input, then press SHIFT, POWER METER ZERO, to display 0.00dBm.
2. Select the Noise Generator (N) mode.
3. Press -20 followed by ENTER.
4. Select the appropriate Noise Band or external filter.

The 3708A now has a noise level of -20dBm present at the NOISE OUTPUT. This power level can be incremented in 0.1dB steps using the Up/Down keys.

Using the NOISE DENSITY (No) mode

The generated noise can also be defined as the Noise Density ie, the power per unit of bandwidth in dBm/Hz. The conversion between noise power and noise density, for a selected filter bandwidth, is automatically carried out by the 3708A. Since the noise density is the power per unit of bandwidth, it will vary according to the filter selected, for a given fixed noise power.

To define a NOISE DENSITY

1. Calibrate the Power Meter by pressing POWER METER, to select the Power Meter mode and linking the 0dBm REF OUTPUT to the POWER METER input, then press SHIFT, POWER METER ZERO, to display 0.00dBm on the front panel.
2. Press No, -80, ENTER.
3. Select the appropriate NOISE BAND or external filter.

The 3708A will generate the appropriate noise to provide a noise density of -80dBm/Hz. This will remain constant regardless of the filter selection but the noise power will vary accordingly.

Selecting a NOISE BAND Filter

The 3708A has four internal band-limiting filters which allow the user to limit the bandwidth of the NOISE OUTPUT to a desired range and avoid any risk of generating noise over excessive bandwidths and overloading receiver input circuits.

These filters are bandpass filters. Each filter is labelled in terms of its centre frequency and flat-top bandwidth, except for the 10-200MHz bandpass filter. The equivalent noise bandwidth is displayed in the right hand window of the display. To select one of the internal filters, press the appropriate key in the NOISE BAND section of the front panel.

The selectable ranges are shown below with their equivalent noise bandwidths (NBW).

Table 3-1 Typical Internal Noise Bandwidth

NOISE BAND Filters	NBW
70±5	17.8MHz
70±20	59.2MHz
140±40	121.5MHz
10-200	215MHz

Using an EXTERNAL Filter

For special requirements, an operator supplied external filter can be used instead of the standard internal filters. The filter used must have a particular noise bandwidth to insertion loss or gain ratio. This ratio and the allowable tolerance on it is shown diagrammatically in Figure 3-2.

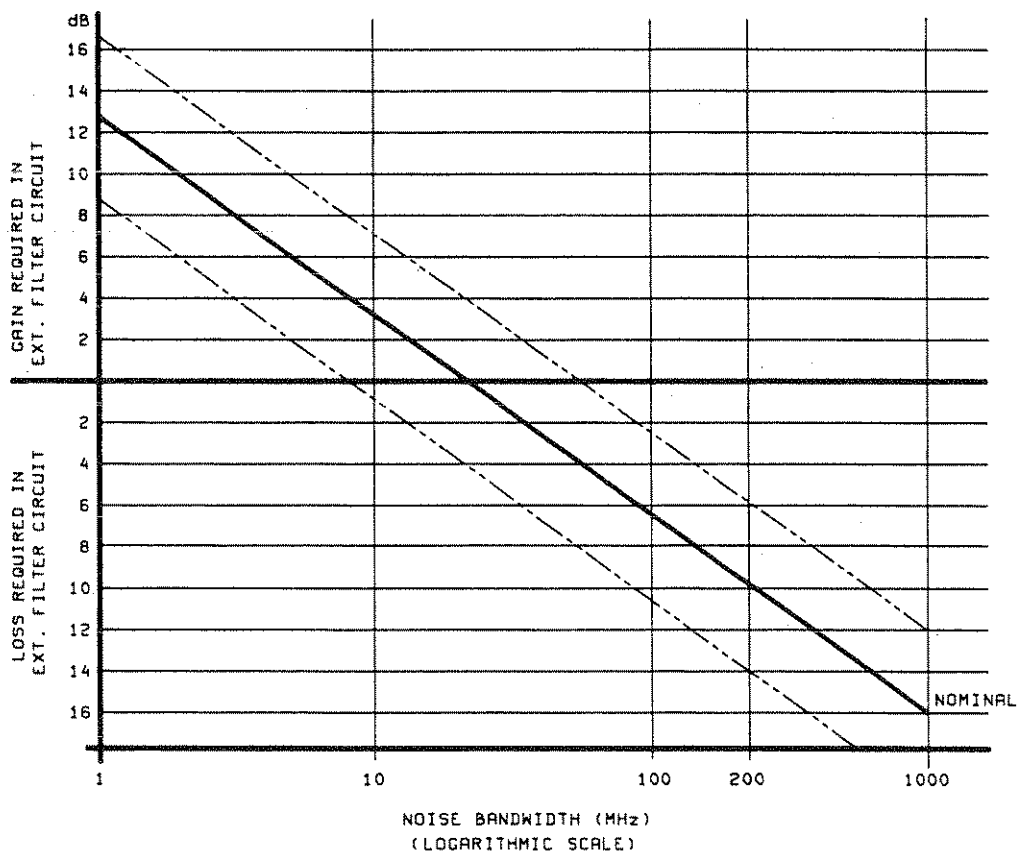

Figure 3-2 Noise Bandwidth to Insertion Loss/Gain Ratio

The filter noise bandwidth must be specified by entering its value or by direct measurement using the 3708A.

To enter an external filter noise bandwidth of 30MHz.

Press ENTER NBW, 30, ENTER

To measure the noise bandwidth of the external filter.

1. Connect the filter between the 0dBm REF OUTPUT and the POWER METER input and select the appropriate Reference frequency.
2. Press INS LOSS MEASURE . The value will be displayed.
3. Remove the filter and connect it between the POWER METER input and the NOISE OUTPUT.
4. Press NOISE BW MEASURE The value will be displayed.
5. Press SHIFT, TRANS N BW

The Noise Bandwidth of the external filter is now entered and will be displayed on the front panel.

To select the EXT FILTER.

1. Connect the filter between two FILTER connectors in the EXT FILTER section of the front panel.
2. Press SELECT.

Disabling the NOISE OUTPUT

The generated noise can be switched OFF or ON as required by pressing the NOISE ON/OFF key.

★ NOISE BW (bandwidth) MEASUREMENT AND INSERTION LOSS

Insertion loss and noise bandwidth are grouped together since insertion loss is required when making a Noise BW (bandwidth) measurement. These topics are discussed in the following order.

- INSERTION LOSS
- NOISE BW (bandwidth)

INSERTION LOSS

The instrument can be used to measure the insertion loss of:

- Cables,
- Attenuators,
- External filters.

The insertion loss of external filters must be checked prior to a noise bandwidth measurement.

Insertion loss is measured at either 70MHz or 140MHz using the 0dBm REFERENCE OUTPUT signal and the POWER METER.

Making an Insertion Loss Measurement

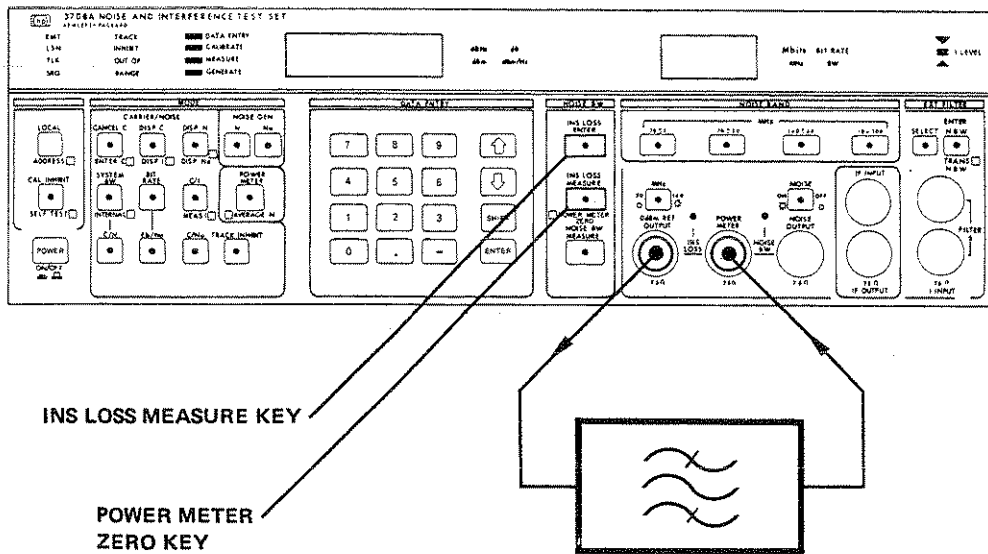

Figure 3-3 Insertion Loss Set-up

1. Select the Power Meter mode by pressing the POWER METER key.
2. Calibrate the Power Meter by:

- a) Linking the 0dBm REFERENCE OUTPUT signal to the POWER METER input.
 - b) Press the SHIFT and POWER METER ZERO keys to display 0.00dBm on the front panel display.
3. Connect the cable, attenuator or external filter between the 0dBm REF OUTPUT and the POWER METER input.
 4. Press the INS LOSS MEASURE key. The resultant insertion loss is stored in memory (for Noise Bandwidth measurements) and also displayed on the front panel.

NOISE BW (bandwidth)

A user-supplied external filter can be used in place of the standard internal filters of the 3708A. This feature allows the 3708A to be used in systems where specially shaped IF filters are necessary.

To maintain measurement accuracy the following parameters of the external filter must be compensated for by the 3708A.

- *Insertion Loss (see preceding section)*
- *Noise Bandwidth*

When the external filter insertion loss and bandwidth are unknown the 3708A can be used to measure these parameters. The resultant insertion loss and bandwidth measurements are stored in the 3708A memory and used to maintain measurement accuracy. *The limits for noise bandwidth and insertion loss of the external filter are explained in Page 23.*

When the external filter insertion loss and bandwidth are known, these parameters are keyed into the 3708A memory via the front panel keyboard.

Making a NOISE BW (bandwidth) Measurement

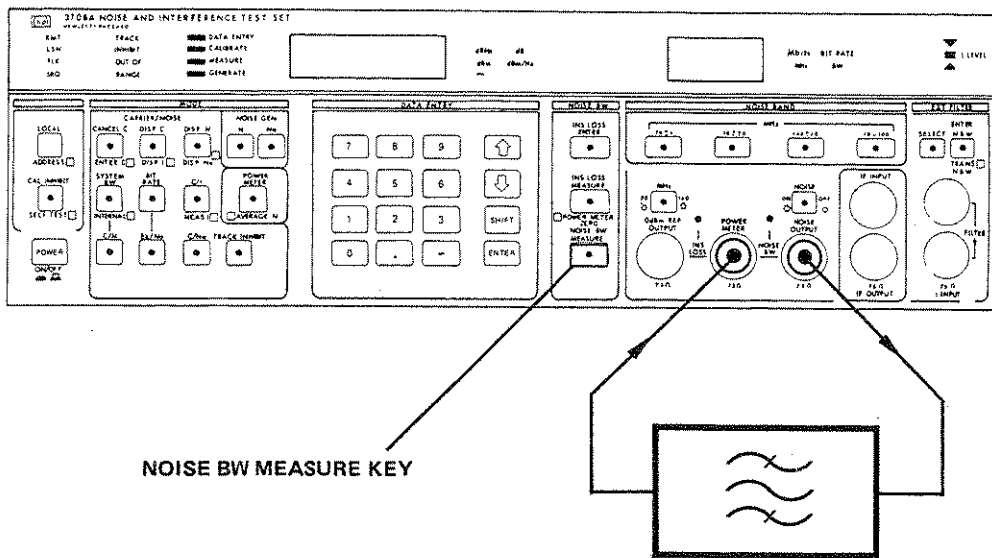

Figure 3-4 Noise Bandwidth Set-up (step 3)

Note : If the insertion loss of the filter is known, steps 1 and 2 can be omitted and the insertion loss can be entered using the INS LOSS ENTER key.

1. Connect the filter between the OdBm REF OUTPUT and the POWER METER input and select the appropriate Reference Frequency.
2. Press the INS LOSS MEASURE key.
3. Disconnect the filter and connect it between the POWER METER input and the NOISE OUTPUT.
4. Press the NOISE BW MEASURE key.
5. Press the SHIFT, TRANS N BW key.

The insertion loss is automatically stored in the 3708A memory for use in the noise bandwidth calculation.

A specific noise density is set up at the NOISE OUTPUT and the Noise Power is measured at the POWER METER input. From the results obtained the NOISE BANDWIDTH is calculated and displayed on the front panel.

The value from step 4 is now entered into the 3708A memory. The external filter can be used in noise measurements as the 3708A now ensures that measurement accuracy is maintained.

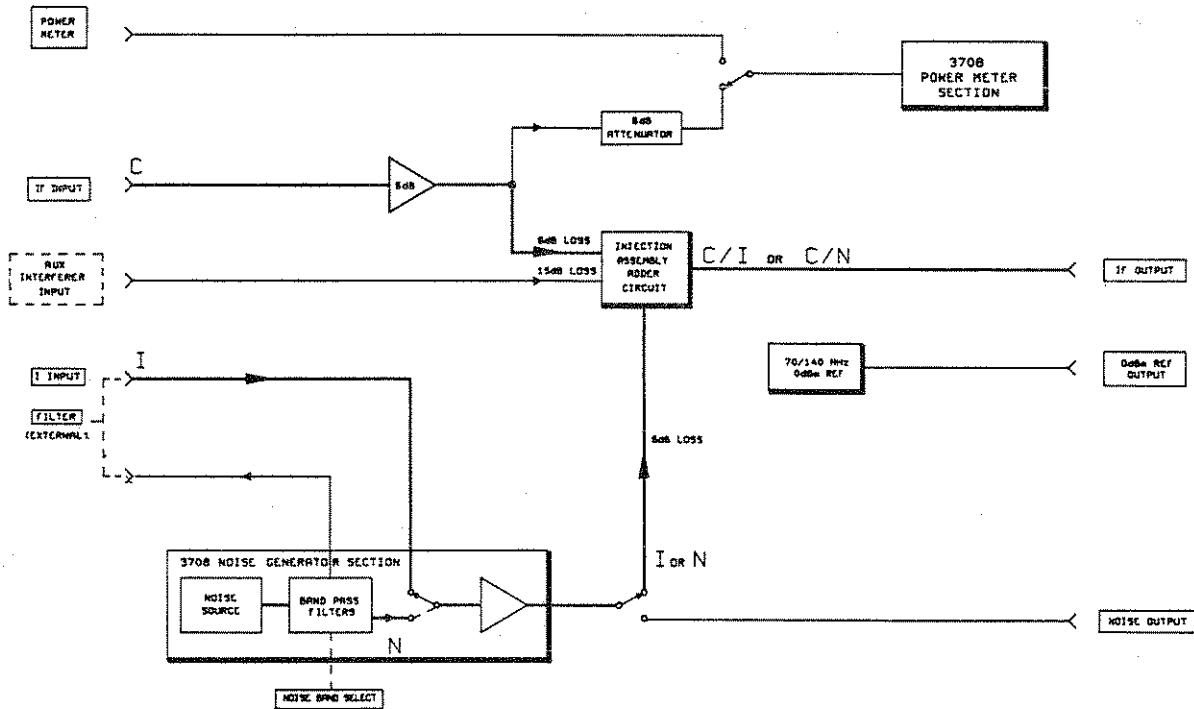
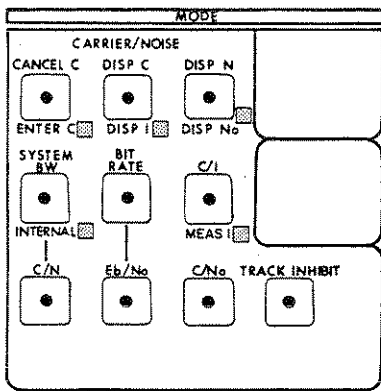
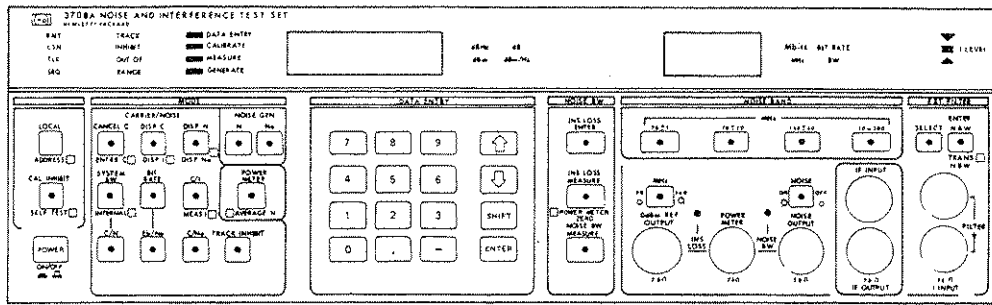

Figure 3-5 Signal Paths Used in Carrier/Noise Measurements

★ CARRIER + NOISE and/or INTERFERENCE MIXER

The main measurement modes discussed in this section are:

- CARRIER TO NOISE RATIO,
- CARRIER TO NOISE RATIO & INTERFERER
- CARRIER TO INTERFERENCE RATIO

In the CARRIER to NOISE mode the instrument can be considered as a combination of Power Meter and Noise Generator. Where the generated noise power is a function of the requested Carrier to Noise ratio and the measured Carrier Power. A constant Carrier to Noise ratio is maintained by measuring the Carrier Power and adjusting the generated noise level accordingly ie, the noise level tracks the carrier power. A track inhibit facility allows the noise level to remain fixed and the C/N ratio to vary with variations in Carrier Power level.

An AUX INTERFERER INPUT on the rear panel of the instrument allows ratio measurements of CARRIER TO NOISE WITH INTERFERER (C/N +I) tone to be made. In this operating mode the Interferer tone is fixed and (unless the tracking is inhibited) the noise level is adjusted to maintain a constant Carrier to Noise ratio with an added Interferer.

A third ratio mode of operation, CARRIER TO INTERFERENCE (C/I) tone allows a fixed tone of $-29\text{dBm} \pm 2\text{dB}$ to be injected via the front panel I INPUT (marked green on the front panel). The tracking within the instrument allows a constant carrier to interference ratio to be maintained by (internally) adjusting the interference power level.

CARRIER TO NOISE MEASUREMENT MODES

The CARRIER TO NOISE ratio can be expressed in three different units.

- C/N - Carrier Power to Noise Power ratio. In this mode the appropriate Noise Band filter must be selected. Where measurements are being made on a radio system or other network, the system bandwidth of that system, or network may be entered. (*See Page 30 on System Bandwidth.*)
- C/No - Carrier Power to Noise Power Density ratio. In this mode no additional information need be entered.
- Eb/No - Energy per bit to Noise Power Density ratio. In this mode the bit rate has to be entered to allow the 3708A to calculate the equivalent energy per bit (*see Page 33.*)

In these three measurement modes the tracking facility can be inhibited by pressing the TRACK INHIBIT key. The generated Noise Power and Noise Power density now remain constant regardless of changes in carrier power. This facility is particularly useful when the carrier level is changing too rapidly to be measured, as in burst mode transmissions such as with TDMA (Time division multiple access) - *see Page 36 for further information.*

Making a C/N (Carrier to Noise) Measurement

Two examples of C/N measurements are given here. The first shows how to set a C/N ratio at the 3708A IF OUTPUT. The second example illustrates a more practical application using the 3708A with a radio receiver which has a known system bandwidth.

Example 1. - Setting C/N Ratio

1. Connect a suitable carrier signal, with a level of preferably around -5dBm to the IF INPUT.
2. Select the appropriate filter using the NOISE BAND select keys (e.g. 70 ± 20).
3. Press the C/N key. The 3708A performs a calibration cycle and enters the C/N mode with the LED in the C/N key flashing to indicate that this parameter is ready for data entry.
4. Press 10, ENTER.
The 3708A now displays 10.0 indicating a C/N ratio of 10dB is present at the IF OUTPUT.

NOTE:- the LED continues to flash indicating that this parameter is currently displayed and can be altered as required.

Example 2 - System Bandwidth

When the 3708A is used to make measurements on a digital radio receiver it will be desirable to establish in some instances a known C/N ratio at a suitable test point in the receiver. The SYSTEM BW bandwidth key is used in the C/N mode to enter the noise bandwidth of the radio system under test. The 3708A now takes into account the noise bandwidth of the filters within the radio receiver and the effect they have on the available noise power, which affects the C/N ratio. The C/N ratio entered is the ratio present at the monitor test point in the radio receiver and not at the 3708A front panel IF OUTPUT. For further information on System Bandwidth see Appendix A.

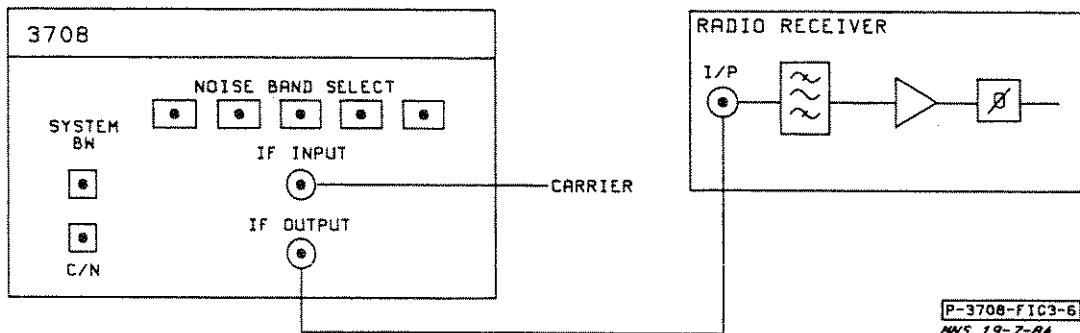

Figure 3-6 Using the 3708A in a Radio Receiver

NOTE : The NOISE BAND selected on the 3708A should be greater than the system noise bandwidth of the external equipment.

The following procedure illustrates how to set a defined C/N ratio at a monitor point in a radio receiver. If the radio receiver operates with a 70MHz IF and has a noise bandwidth of 30MHz; to set up a C/N ratio of 10dB with a carrier of -5dBm, proceed as follows:

1. Connect the carrier signal to the 3708A IF INPUT.
2. Press C/N, 10, ENTER. This selects a C/N ratio of 10dB.
3. PRESS 70±20. This gives a noise bandwidth of typically 59.2MHz -see Table 3-1. If the DISP N key is pressed the noise power displayed should be approximately -15dBm.
4. Press SYSTEM BW, 30, ENTER. This enters the system noise bandwidth of 30MHz ie. approximately half the noiseband width in step 3. If the DISP N key is pressed once again, the result should be 3dB greater than in step 3, ie. -12dBm indicating the noise power has doubled with a reduction to half the noise bandwidth - thus maintaining a constant C/N ratio.

To return the 3708A to C/N operation using the internal NOISE BAND filters press keys SHIFT, INTERNAL.

Additional Features Available in the C/N Mode

- DISP C - Press this key to display the CARRIER LEVEL at the IF INPUT.
- DISP N - Press this key to display the NOISE POWER being generated by the instrument to maintain the defined C/N ratio.
- SHIFT, DISP No - Press these keys to display the calculated NOISE DENSITY.
- TRACK INHIBIT - Press this key to allow the C/N ratio to vary with changes in carrier level - see Page 36.
- SHIFT, ENTER C - Press these keys to allow entry of a carrier level, this automatically sets TRACK INHIBIT - see Page 36.

Making a C/No (Carrier to Noise Density) Measurement

The carrier to noise ratio can also be defined as the carrier power to noise power density. The following example shows how to set a C/No ratio of 80dBm/Hz at the 3708A IF OUTPUT.

1. Connect a suitable carrier signal, with a level of around -5dBm to IF INPUT.
2. Select the appropriate NOISE BAND (e.g. press 140 ± 40).
3. Press the C/No key.

The 3708A performs the calibration cycle and enters the C/No mode with the LED in the C/No key flashing to indicate that this parameter is ready for data entry.

4. Press 80, ENTER. A C/No ratio of 80dBm/Hz is available at the IF OUTPUT. The LED in the C/No key continues to flash, indicating that this parameter is currently being displayed on the front panel. No further information is required when the carrier to noise ratio is defined as C/No.

Additional Features in the C/No Mode

- DISP C - Press this key to display the CARRIER LEVEL at the IF INPUT.
- SHIFT, DISP No - Press these keys to display the NOISE DENSITY being generated by the instrument to maintain the defined C/No ratio.
- DISP N - Press this key to display the equivalent NOISE POWER.
- TRACK INHIBIT - Press this key to allow the C/No ratio to vary with changes in carrier level - see Page 36.
- SHIFT, ENTER C - Press these keys to allow entry of a carrier level, this automatically sets the TRACK INHIBIT -see Page 36.

Making an Eb/No (Energy per Bit to Noise Density) Measurement

Eb/No defines the generated noise level as the ratio of energy per bit to noise density. Since the 3708A only measures the Carrier power, the BIT RATE must be entered to allow the instrument to calculate the equivalent energy per bit, using the relationship $E_b = \text{Carrier power} / \text{Bit rate}$.

The following example shows how to set an Eb/No ratio of 17dB at the 3708A IF OUTPUT.

1. Connect a suitable carrier signal, with a level of preferably around -5dBm to the IF INPUT.
2. Press BIT RATE, 15, ENTER. A bit rate of 15Mbits/sec is entered into the 3708A memory and used to calculate the energy per bit.
3. Press Eb/No. The LED in the Eb/No key flashes to indicate that this parameter is ready for data entry.
4. Press 17, ENTER. The noise generated will produce an Eb/No ratio of 17dB at the IF OUTPUT. Note:- The LED in the Eb/No key continues to flash indicating that this parameter is currently being displayed and can be altered as required.

Additional Features in the Eb/No Mode

- DISP C - Press this key to display the CARRIER LEVEL at the IF INPUT.
- DISP N - Press this key to display the NOISE POWER being generated.
- SHIFT, DISP No - Press these keys to display the equivalent NOISE DENSITY required to maintain the defined Eb/No ratio.
- TRACK INHIBIT - Press this key to allow the Eb/No ratio to vary with changes in carrier level -see Page 36
- SHIFT, ENTER C - Press these keys to allow entry of a carrier level, this automatically sets the TRACK INHIBIT -see Page 36.

★ CARRIER TO NOISE WITH INTERFERER TONE MEASUREMENT MODE

The AUXiliary INTERFERER INPUT on the rear panel allows a single tone between 10 and 200MHz to be injected via a 15dB path loss and added to the carrier signal and the generated noise.

To add this interferer tone; Connect it to the AUX INTERFERER INPUT on the rear panel and the internal circuitry of the 3708A mixes it with the carrier and noise. This interferer is non-tracking and has a fixed loss of 15dB.

★ CARRIER TO INTERFERENCE MEASUREMENT MODE

A front panel input, I INPUT, is provided for injection of an external interfering tone. This port accepts a broadband input, allowing a wide range of interfering signals to be used. The instrument requires a level of $-29\text{dBm} \pm 2\text{dB}$ at this port. Once this level is supplied the 3708A uses its internal circuitry to adjust the interference signal power level at the IF OUTPUT as required, to provide the requested C/I ratio for a measured carrier power. The interference signal replaces the noise generator output at the bandpass filters output section.

Making a C/I (Carrier to Interference) Measurement

The following example shows how to set a Carrier to Interference ratio (C/I) of 10dB at the IF OUTPUT.

1. Connect a suitable carrier signal, with a level of preferably around -5dBm to the IF INPUT.
2. Connect the Interference tone to the I INPUT.
3. Press the C/I key. The 3708A performs a calibration cycle and enters the C/I mode with the LED in the C/I key flashing to indicate that this parameter is ready for data entry.
4. Press 10, ENTER. The 3708A power meter measures the interference signal at the I INPUT and the I LEVEL annunciators indicate whether the level is too high, too low or suitable to maintain the demanded C/I ratio. If the ▼ indicator is on, reduce the interference level and if the ▲ indicator is on, increase the interference level until the ■ indicator is on.

A C/I ratio of 10dB is now available at the IF OUTPUT. The LED in the C/I key continues to flash, indicating that this parameter is currently being displayed and can be altered as required.

This interference tone tracks the carrier power and maintains the selected C/I ratio unless the TRACK INHIBIT is selected.

To recheck the interference tone at the I INPUT, press SHIFT, MEAS I and the I LEVEL annunciators indicate whether the level is suitable.

The Interference tone and signal path is also rechecked and recalibrated during the following conditions:-

- self calibration cycle (due to a temperature change)
- exiting and re-entering the C/I mode
- or by HP-IB command.

★ AVAILABLE FEATURES

Tracking

The 3708A tracking facility allows the instrument to maintain a user defined carrier to noise ratio. It is available in the C/N mode, the C/I mode and the Eb/No mode. In each case the carrier signal is measured every 10m secs and the generated noise is adjusted accordingly to maintain a constant Carrier to Noise ratio or Carrier to Interference ratio.

Track Inhibit

When using the 3708A in such conditions as Time Division Multiple Access (TDMA) where carrier bursts are present, it is useful to stop the generated noise responding to carrier power variations.

To use this facility on the 3708A press the TRACK INHIBIT key, the LED in the key lights to indicate the mode is selected. The 3708A uses the last measured carrier power value to complete the generated noise power, with no further updates.

With this facility, the C/N ratio can be set in the normal tracking mode using an unmodulated carrier and then, with Track Inhibit, modulation can be applied while the noise remains constant at its current level.

To exit this mode, press the TRACK INHIBIT key again, the LED switches off and the 3708A returns to normal operation.

Enter Carrier Power/Cancel

A value of carrier power can be entered via the front panel rather than using the measured carrier, to establish a non-tracking C/N ratio.

This mode is useful for systems such as TDMA where the carrier bursts cannot be measured by the instrument.

To enter a carrier power

Press SHIFT, ENTER C, -5

(This automatically sets the 3708A to a non-tracking mode)

A carrier power of -5dBm is entered and the various ratios are calculated using this level.

To exit this facility

Press CANCEL C.

The 3708A returns to normal operation.

4 QUICK MEASUREMENT SETTINGS

The aim of this section is to provide "quick measurement settings" for the more common features of the instrument using step by step examples.

Calibrating the POWER METER

Before making any measurements using the 3708A it is necessary to calibrate the Power Meter ie:

1. Press the POWER METER key.
2. Link the 0dBm REF OUTPUT to the POWER METER input.
3. Press SHIFT, POWER METER ZERO.

The 3708A measures the power at the POWER METER input and generates a correction factor to make the display read 0.00dBm. Provided the same cable is used for subsequent power measurements, the results are referenced to the accuracy of the 0dBm REF OUTPUT.

Making a Power Measurement

1. Calibrate the Power Meter (*see this page*).
2. Connect the signal to be measured to the POWER METER input, via the cable used in calibration. The result is displayed in the left hand display window.

Using the AVERAGE N Feature of the POWER METER Mode

When the signal being measured is noisy, the averaging facility can be used to give a flicker free display. The averaging constant selected can be between 0 and 200.

To select an AVERAGE N constant:

1. Calibrate the Power Meter (*see this Page*).
2. Connect the signal to be measured to the POWER METER input, via the cable used in calibration.
3. Press SHIFT, AVERAGE N, 20, ENTER. (Assuming 20 is the constant selected.)
The 3708A calculates the power and displays it using the algorithm:

$$\text{NEW DISPLAY} = (\text{N} \times \text{CURRENT DISPLAY} + \text{RMS VALUE}) / (\text{N} + 1)$$

Generating NOISE POWER

In the following example the 3708A produces a power level of -20dBm at the NOISE OUTPUT. This level can be incremented or decremented using the Up/Down keys to the limits of the range, +5.9dBm to -86.8dBm.

1. Calibrate the Power Meter (*see Page 37*).
2. Press N, -20, ENTER.
3. Select the appropriate Noise Band or External Filter. e.g. 70±5MHz

Generating Noise Defined as a NOISE DENSITY

In this example the 3708A generates the appropriate noise to provide a Noise Density of -80dBm/Hz.

1. Calibrate the Power Meter (*see Page 37*).
2. Press No, -80, ENTER.
3. Select the appropriate Noise Band or Ext Filter. e.g. 70±5MHz.

Selecting a NOISE BAND Using Internal Filters

The 3708A has four internal band-limiting filters, 70±5MHz, 70±20MHz, 140±40MHz and 10-200MHz. These allow the user to limit the bandwidth of the noise to a desired range and avoid any risk of generating noise over excessive bandwidths and overloading receiver input circuits. To select one of these bands, press the appropriate key in the NOISE BAND section of the front panel.

Selecting a NOISE BAND Using External Filters

To use an external filter instead of the standard internal filters, the filter noise bandwidth is required. This value can be entered directly or measured if it is unknown.

When the value is known:

1. Connect the filter between the two FILTER ports on the front panel.
2. Press ENTER NBW, 30, ENTER. Assuming the Noise bandwidth of the filter is 30MHz.
3. Press SELECT in the EXT FILTER section of the front panel.

When the value is unknown:

1. Connect the filter between the 0dBm REF OUTPUT and the POWER METER input.
2. Select a reference output of either 70 or 140 MHz, as required using the REF key.
3. Press INS LOSS MEASURE. The insertion loss of the filter is stored in the 3708 memory and used in the calculation for the noise bandwidth.
4. Remove the filter and connect it between the POWER METER input and the NOISE OUTPUT.
5. Press NOISE BW MEASURE. The value will be displayed.
6. Press SHIFT, TRANS N BW. The noise bandwidth of the filter is now entered and will be displayed on the front panel.
7. Remove the filter and connect it between the two FILTER connectors.
8. Press SELECT in the EXT FILTER section of the front panel.

Entering the NOISE BANDWIDTH of an External System

In the C/N measurement mode, when the radio receiver connected to the 3708A IF OUTPUT contains a band-pass filter, the band-limiting effect of this filter reduces the total noise power, thus affecting the C/N ratio. By entering the system noise bandwidth, the 3708A adjusts the noise power to the appropriate level to maintain the required C/N ratio at the output of the radio receiver filter.

Example:

If the receiver operates with 70MHz IF and the noise bandwidth is 30MHz, to maintain a C/N ratio of 10dB with a carrier level of -5dBm adjust the 3708A as follows.

1. Press C/N, 10, ENTER.
2. Press 70±20.
3. Press SYSTEM BW, 30, ENTER.

The 3708A now automatically adjusts the noise level to maintain a constant C/N ratio at the output of the radio receiver filters. The C/N ratio at the filter output is 10dB but at the 3708A IF OUTPUT the C/N ratio is 7.1dB.

To return to the C/N mode using the 3708A internal filters:

Press SHIFT, INTERNAL.

The 3708A will return to C/N operation using the noise bandwidth of the 3708A internal filters.

Setting a CARRIER to NOISE Ratio

In the following example the 3708A produces a C/N ratio of 10dB at the IF OUTPUT.

1. Calibrate the Power Meter (*see Page 37*).
2. Connect the carrier signal to the IF INPUT and if required enter the System Bandwidth.
3. Press the C/N key. The 3708A will perform a calibration cycle then enter the C/N mode. The LED on the C/N key will flash to indicate that this parameter is ready for data entry.
4. Press 10, ENTER
5. Select the appropriate filter using the NOISE BAND keys.

Setting a CARRIER to NOISE DENSITY Ratio

In the following example the 3708A produces a C/No ratio of 80dBm/Hz at the IF OUTPUT.

1. Calibrate the Power Meter (*see Page 37*).
2. Connect the carrier signal to the IF INPUT
3. Press C/No, The LED on the C/No. key flashes to indicate that this parameter is ready for data entry.
4. Press 80, ENTER.
5. Select the appropriate filter using the NOISE BAND keys.

Setting an ENERGY PER BIT to NOISE DENSITY Ratio

In the following example the noise generated produces an Eb/No ratio of 17dB at the IF OUTPUT.

1. Calibrate the Power Meter (*see Page 37*).
2. Enter a Bit Rate of 15Mbits/sec by pressing the keys BIT RATE, 15, ENTER.
3. Press Eb/No. The LED in the Eb/No key flashes to indicate that this parameter is ready for data entry.
4. Press Eb/No, 17, ENTER

Setting a CARRIER to INTERFERENCE Ratio

An interference tone can be injected into the 3708A to provide a C/I ratio at the IF OUTPUT.

1. Calibrate the power meter (*see Page 37*).
2. Connect the carrier signal to the IF INPUT.
3. Connect the Interference tone to the I INPUT.
4. Press C/I, 10, ENTER

The 3708A power meter measures the Interference signal power level and the front panel I LEVEL annunciators indicate whether the level is too high, too low or suitable to maintain

the demanded C/I ratio. If the ▼ indicator is illuminated, reduce the interference level and if the ▲ indicator is illuminated, increase the interference level until the ■ indicator is lit.

Measuring CARRIER POWER at the IF INPUT

To measure the carrier power at the IF INPUT:

1. Press the C/N key, to enter the C/N mode.
2. Press DISP C.

The power meter measures the level at the IF INPUT and displays the value on the front panel.

Displaying Generated Noise or Interference at the IF OUTPUT

The DISP N and DISP I keys are used to display the generated Noise or Interference at the IF OUTPUT. *Note the displayed value is not measured but calculated by the 3708A.*

To display the noise power on the front panel display:

1. Press C/N.
2. Press DISP N.

The value will be displayed on the front panel.

To display the Interference Power on the front panel display.

1. Press C/I
2. Press SHIFT, DISP I

Measuring NOISE BW (bandwidth)

To measure noise bandwidth of an external filter, the insertion loss must first be measured and used in the calculation of the noise bandwidth.

To measure noise bandwidth:

1. Calibrate the Power Meter (*see Page 37*).
2. Connect the filter between the 0dBm REF OUTPUT and the POWER METER input.
3. Press INS LOSS MEASURE.
4. Remove the filter and connect it between the POWER METER input and the NOISE OUTPUT.
5. Press NOISE BW MEASURE.

Note:- If the centre frequency of the filter is not 70 or 140MHz, an external 0dBm reference source must be used in place of the 3708A 0dBm REF OUTPUT at steps 1, 2 and 3.

Measuring Insertion Loss

The INS LOSS MEASURE facility can also be used to measure the insertion loss of attenuators and cables.

To do this:

1. Calibrate the Power Meter (*see Page 37*).
2. Connect the attenuator or cable between the 0dBm REF OUTPUT and the POWER METER input.
3. Press INS LOSS MEASURE.

The insertion loss is measured and displayed on the front panel.

Entering Insertion Loss

If the Insertion loss of the external filter being used is known, there is no need to measure it, as the value can be entered directly into the 3708A memory as follows.

Press the keys INS LOSS ENTER, 2, ENTER.

INSTRUMENT DEFAULT PARAMETER

At switch on the 3708A enters the POWER METER mode and establishes known "default" parameters.

Table 4-1 3708A Default Parameters

Carrier to Noise Ratio (C/N)	10dB
Carrier to Noise Density (C/No)	87.7dBHz
Energy per bit to Noise Density (Eb/No)	17.7dB
BIT RATE	10MBit/s
Carrier to Interference C/I	10dB
ENTER C	OFF
SYSTEM BW	59.7MHz
TRACK INHIBIT	OFF
Noise Power (N)	-12.3dBm
Noise Density (No)	-90dBm/Hz
NOISE	ON
AVERAGE N	10
INS LOSS ENTER	0
Reference Tone (70/140)	70MHz
NOISE BAND SELECT	70±20MHz
ENTER N BW (External Filter)	200MHz
CAL INHIBIT	OFF
SRQ MASK (HP-IB)	255 (all enabled)
RQS ON (HP-IB)	set
ASCII (HP-IB)	set

5 OPERATOR'S CHECKS

The main operating functions of the HP 3708A are verified using the following test equipment and procedure.

TEST EQUIPMENT

Power Meter	HP436A
Synthesiser	HP3335A
Spectrum Analyser	HP8568A

1. Connect the Power Meter to the 3708A 0dBm REF OUTPUT. Select the 70MHz reference tone. The Power Meter should read 0dBm \pm 0.3dB. Select the 140MHz reference tone, the Power Meter should read \pm 0.3dB Press the reference button on the power meter.

2. Connect the 0dBm REF OUTPUT to the 3708A POWER METER input using the cable supplied, select the Power Meter mode, Press SHIFT, POWER METER ZERO. The Power Meter should read 0.00dBm \pm 0.02dBm.

3. Having set the Synthesiser to 70MHz and 0dBm connect it to the POWER METER input of the 3708A. The Power Meter should read 0dBm \pm 0.02dBm, if this is not the case there is a discrepancy between the Power Meter being used and the Synthesiser.

4. Set the Synthesiser to various levels from +5dBm to -35dBm and check that the 3708A display and the Synthesiser output level agree \pm 0.1dB. Reduce the Synthesiser output level to -45dB and ensure that the 3708A display and the Synthesiser level agree \pm 0.3dB.

5. Connect the Power Meter to the 3708A NOISE OUTPUT. Select Noise at 0dBm for each internal filter. The Power Meter should read 0dB \pm 0.1dB.

6. Connect the 3708A NOISE OUTPUT to the input of the Spectrum Analyser. Select Noise at 0dBm using the 70 \pm 5MHz filter. On the Spectrum Analyser adjust the Centre Frequency, Frequency span and Reference level to give a display near the top of the display screen. Use the Video Bandwidth Control to remove the noise on the display and then note the level at a particular frequency.

NOTE: The noise power displayed will NOT be 0dBm.

7. Reduce the 3708A Noise output in steps to -55dBm and ensure that the Spectrum Analyser display follows it $\pm 1\text{dB}$.
8. Repeat for the other 3708A NOISE BANDS.
9. Connect the 0dBm REF OUTPUT to the IF INPUT using the short cable supplied. Connect the Power Meter to the 3708A IF OUTPUT. Select the C/N mode and switch the Noise OFF. The Power Meter should read $0\text{dB} \pm 0.2\text{dB}$. Select the C/N mode, $70 \pm 5\text{MHz}$ filter, 0dBm . Switch the Noise ON. Select TRACK INHIBIT, remove the signal from the IF INPUT. The Power Meter should read $0\text{dB} \pm 0.7\text{dB}$. Deselect the TRACK INHIBIT. Repeat for the other internal filters.
10. Set the Synthesiser to 0dBm and 70MHz and connect it the 3708A IF INPUT. Select the $70 \pm 5\text{MHz}$ filter on C/N at 10dB . Connect the 3708A IF OUTPUT to the Spectrum Analyser input and adjust the Spectrum Analyser to display the Carrier at 70MHz and the noise being generated. *Note the Carrier to Noise Ratio. It will NOT be 10dB .*
11. Vary the output level of the Synthesiser $\pm 5\text{dB}$ and check on the Spectrum Analyser display that the Carrier to Noise ratio remains at the figure noted in step 10.

6 HEWLETT-PACKARD INTERFACE BUS (HP-IB)

Many users will be familiar with some or all aspects of programming/ configuring instruments over the HP-IB. This section deals mainly with programming the 3708A and is broken down as follows:

• Introduction	Page 46
• Operating Distances	46
• HP-IB Capability	47
• Addressing The 3708A	47
• HP-IB Address Switch	49
• Remote Operation Of The 3708A	49
• Message Format	50
• Reading Data From The 3708A - (ASCII Mode)	50
• Simple Programs For Reading Data From The 3708A	52
• Binary Mode	53
• 3708A Status Request Codes	53
• The 3708A Requesting Service (SRQ)	54
• Status Bytes	54
• SRQ Mask	55
• SRQ On/Off	55
• HP-IB Universal Commands	56
• 3708A Data Message Commands (key action)	59
• 3708A Data Message Commands (functional)	62
• Sample Program	66

Introduction

The Hewlett-Packard Interface Bus (HP-IB) is Hewlett-Packard's implementation of IEEE standard 488-1978, ANSI standard MC 1.1 and IEC Recommendation 625-1.

The HP-IB is a bus structure which allows instruments to be linked together, usually with a suitable controller such as an HP 200 series desk top computer, to form an automated measurement system.

Devices operating on the bus fall into at least one of three categories, talkers, listeners or controllers. As an example of the simplest system (ie without a controller), one instrument could be configured to continuously send data - known as "TALKING" and the other instrument (such as a printer) could be configured to continuously receive data - known as "LISTENING". Most devices can perform both roles "TALK" or "LISTEN", but not simultaneously. Usually a controller manages the operation of which instrument "TALKS" and which instrument "LISTENS".

The 3708A can "TALK" and "LISTEN", but only when it is designated to do so by a suitable controller. The controller may also "manage" other instruments connected in the same bus configuration, addressing only one instrument at a time, to carry out the data transfer or "TALK" function. An example of an instrumentation system is the HP 3708S system where a 3708A is used in conjunction with a bit-error-rate test set such as the HP 3764A or the HP 3781B/82B and an HP 200 series/computer to characterise digital radio performance during simulated (flat) fading conditions.

Further information on HP-IB standards and concepts is available in the following publications.

IEE Interface Standard 488-1975

ANSI Interface Standard MC1.1

"Improving Measurements in Engineering and Manufacturing"

(HP Part No 5952-0058)

"Condensed Description of the Hewlett-Packard Interface Bus " (HP Part No 59401-90030)

Operating Distances

Up to 15 instruments can be connected on a local bus system, but it is important to ensure that the maximum HP-IB cable length between instruments is less than 2 metres. In addition the total cabling should not exceed 20 metres.

Some useful cable part numbers are listed below.

Cable Part Number

Length	Part Number	
1m	HP 10833A	For distances up to 1000m a suitable bus extender such as a HP 37203A or a HP 37201A can be used. Two bus extenders are required, one at the local bus and one at the remote bus. For distances beyond 1000m two HP 37201A bus extenders with suitable modems must be employed.
2m	HP 10833B	
4m	HP 10833C	
0.5m	HP 10833D	

NOTE:- The 4m cable may work under certain conditions, usually the driver loading has to be altered to ensure satisfactory operation.

HP-IB Capability

The interface functions available with the 3708A are listed in Table 6-1 (compatible with IEE488-1978)

Table 6-1 HP-IB Capability

Code	Description
SH1	Complete source handshake capability
AH1	Complete acceptor handshake capability
T6	Basic talker Serial Poll, Unaddress if My Listen Address (MLA) No Talker only capability
L4	Basic Listener, unaddress if My Talk Address (MTA)
SR1	Complete Service Request capability
RL1	Complete Remote Local capability
PP0	No Parallel Poll capability
DC1	Complete Device Clear capability
DT1	Complete Device Trigger capability
CO	No controller capability

Addressing the 3708A

When configuring a system it is important to remember each device in that system must have a unique address.

- PRESET ADDRESS** The 3708A is factory preset to address 8.
- DISPLAYING THE ADDRESS** The address is displayed in the right hand display window at switch on and can be viewed on demand by pressing keys SHIFT, ADDRESS.
- ADDRESS SWITCH** The address switch is located below the HP-IB connector, and it is best to remove any connecting cables to give maximum ease of access to this switch. If a change of address is required any address between 0 and 30 inclusive can be selected. When selecting an address, remember most HP desk top computers are factory preset to address 21. After selecting a new address the instrument must be powered OFF and ON to enter the new address into memory otherwise the instrument will not operate with its new address.
- TALK/LISTEN ADDRESSES** The talk and listen addresses fall within the printable ASCII character set (See Table 6-2). When a device receives one of these characters while ATN is true, it becomes addressed. (This is the command mode of operation).
- ADDRESSING THE 3708A** With most Hewlett-Packard controllers it is sufficient to use the device address; the controller automatically sends the talk and listen characters. In the case of HP 85A/B, and HP 200 series controllers, which have multiple I/O facilities, the HP-IB interface selected is usually factory preset to 7. Thus to address the 3708A with a factory preset address of 8, the controller sends:-

OUTPUT 708;

Table 6-2 shows the appropriate ASCII characters corresponding to the permissible instrument address settings. These characters are used when the program/system controller uses the command mode of addressing.

Table 6-2 HP-IB Addresses

Device	Talk	Listen
0	@	SP
1	A	!
2	B	"
3	C	6 #
4	D	\$
5	E	%
6	F	&
7	G	'
8	H	([☆]
9	I)
10	J	*
11	K	+
12	L	,
13	M	-
14	N	.
15	O	/
16	P	0
17	Q	1
18	R	2
19	S	3
20	T	4
21	U	5 [☆]
22	V	6
23	W	7
24	X	8
25	Y	9
26	Z	:
27	[;
28	\	<
29]	=
30	~	>

☆ 3708A Factory Preset Address

★ Usually HP Desk Top Controller Preset Address

HP-IB Address Switch

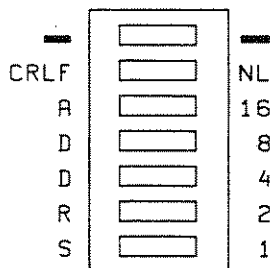

Figure 6-1 Address Switch

- CR/LF NL** The setting of the CR/LF NL switch determines whether data transfer messages (results) returned from the 3708A to the system controller are terminated by the ASCII carriage return line feed CRLF character or the new line NL character. The instrument is factory preset to the CRLF position.
- ADDRS 1,2,4,8,16** The five switch positions shown in Figure 6-1 allow the 3708A HP-IB address to be set to the addresses outlined in Table 6-2. The 3708A is normally factory preset to address decimal 8.

Remote Operations of the 3708A

In most cases programming the 3708A is simply a matter of finding out what the front panel key sequence is and converting this to the appropriate HP-IB data message command codes. See Tables 6-6 and 6-7. There are however some additional points which should be noted.

- The data message command codes are normally three letter mnemonics.
- Several data message command codes can be sent in the same data message, each must however be separated by a comma, a semi-colon or a space. e.g. "CND,DIP".
- Where numeric data is added after a data message command it must be followed by ENT e.g. "AVG 20 ENT". The ENT command is equivalent to pressing the front panel ENTER key. ENT MUST ALWAYS FOLLOW NUMERIC DATA WHEN SENDING MESSAGES OVER THE BUS.

NOTE: The exception to the above is where the numeric data is an integral part of the command code (see Table 6-7).

Message Format

The 3708A has the capability of returning data via HP-IB in the form of an ASCII string with a field width of 18 characters or in the form of two binary bytes.

The ASCII mode is the most common mode of operation and is also the 3708A default mode (at power-on). The returned string is in the form:

##LLL#-NN.NN,###V

= space

LLL = the three letter measurement mnemonic

-NN.NN = the result (The result may be less than 4 digits and may also have the -ve sign omitted. The result is always justified to the right).

V = validity bit, either 1 or 0.

The following list shows the measurement, result and validity bit returned when the results are read using a string variable. The list below also illustrates how the results are justified to the right.

NBM	55.21,	0
NBM	55.34,	0
ILM	6.43,	0
IPW	-19.71,	0
DNP	-25.4,	0
DND	-103.1,	0
DIP	-10.38,	0
DIF	-31.4,	0

Reading Data from the 3708A (- ASCII Mode)

In almost all cases it will be necessary at some time, to read data from the 3708A. To do this the 3708A must be specifically asked to return a reading over the bus. Prior to reading data from the 3708A an HP-IB TRIGGER command or the command code "TRG" must be sent. The 3708A can then be addressed to talk and the data entered into a suitable variable.

The following two examples in HP Basic illustrate how the current measurement result can be retrieved using

- a string variable
- two variables

EXAMPLES

String Variable	Two Variables
10 OUTPUT 708; "TRG" 20 ENTER 708; A\$ 30 DISPLAY A\$ Result displayed IPW -5.45, 0 In this example the result is returned as an ASCII string and the data entry is terminated on receipt of a line feed. The measurement result is preceded by a three letter mnemonic which indicates which measurement result is being displayed.	10 OUTPUT 708; "TRG" 20 ENTER 708;A,B 30 DISPLAY A,B Result Displayed -5.45, 0 In this example variable A contains the measurement result and variable B the validity bit.
The validity bit is set to 0 when the measurement is in range, and set to 1 when the instrument is out of range or in an overload condition.	

Table 6-3 shows the various measurements the 3708A can return via HP-IB and the mode the instrument must be in for the measurement to be valid.

Table 6-3 HP-IB Measurement Codes

Measurement	HP-IB Code	* Valid in Measurement Modes
Carrier Power	DCP or DIP	C/I, C/N, C/No, Eb/No
Interference Power	DIF	C/I
Noise Power Density	DND	C/No, Eb/No, C/N
Noise Power	DNP	C/No, Eb/No, C/N
Power Meter	IPW	ANY
Insertion Loss	ILM	ANY
Noise Bandwidth	NBWM	Noise bandwidth

* The codes to enter these modes are given in Tables 6-6 and 6-7.

Simple Programs for Reading Data from the 3708A

```

10     Z=708
20     OUTPUT Z;"CNP,20,ENT" .....
30     OUTPUT Z;"DIP,TRG"
40     ENTER Z;A$
50     PRINT A$
60     END

```

```
DIP  -5.41,  0
```

```

10     Z=708
20     OUTPUT Z;"CNP,20,ENT" .....
30     OUTPUT Z;"DNP,TRG"
40     ENTER Z;A$
50     PRINT A$
60     END

```

```
DNP  -25.3,  0
```

..... Enters Carrier to Noise mode and sets the C/N ratio at 20.

```

10     Z=708
20     OUTPUT Z;"CNP,20,ENT" .....
30     OUTPUT Z;"DND,TRG"
40     ENTER Z;A$
50     PRINT A$
60     END

```

```
DND  -103.1,  0
```

```

10     Z=708
20     OUTPUT Z;"CIF,20,ENT" ..... Enters Carrier to Interference mode and sets the
30     OUTPUT Z;"DIF,TRG"           C/I ratio at 20.
40     ENTER Z;A$
50     PRINT A$
60     END

```

```
DIF  -49.7,  0
```

```

10     Z=708
20     OUTPUT Z;"IPW,TRG" ..... Enters Power Meter mode
30     ENTER Z;A$
40     PRINT A$
50     END

```

```
IPW  -5.45,  0
```

```

10     Z=708
20     OUTPUT Z;"ILM,TRG" ..... Enters Insertion Loss Measurement mode
30     ENTER Z;A$
40     PRINT A$
50     END

```

```
ILM  0.38,  0
```

```

10     Z=708
20     OUTPUT Z;"NBWM,TRG".....Enters Noise Band width measurement
30     ENTER Z;A$
40     PRINT A$
50     END

```

NBM , 1

This measurement must be preceded by an insertion loss measurement or entry.

Binary Mode

This mode of operation allows a fast data transfer of the measurement result (from the 3708A to the controller). In this mode the 3708A returns the result and validity bit in the form of two data bytes. The first byte containing the measurement result has no decimal point, and must be divided by 100 to provide meaningful power readings. The example program, in HP Basic, can be used with an HP85 or HP200 series controller to give a continuous display of the power meter reading.

```

10     Z=708
20     OUTPUT Z;"bin "
30     TRIGGER Z
40     ENTER Z USING "#,W";A,B
50     DISP A/100,B
60     GOTO 30
70     END

```

Result displayed .32 0

3708A Status Request Codes

The following data message command codes request information or status, and do not require the use of the "TRG" data message command code. These codes always have a ? as an integral part of the code. In all instances the information can be read from the 3708A immediately following the request code. The request codes are as follows:

- ID? Request the HP instrument number.
- NBW? Requests the value of system noise bandwidth currently in use.
- PROG? Requests the current instrument settings.
- REV? Requests the software rev of the instrument.
- SER? Requests the software number of the instrument.
- SRQ? Requests the value of the SRQ byte.



The 3708A Requesting Service (SRQ)

In a bus system, operating with a controller and one or more devices, it is often necessary for a device to inform the controller when it is busy, when an error or failure occurs, or any circumstances which might warrant passing on important information. This is usually accomplished by the device requiring attention issuing a SERVICE REQUEST and the controller carrying out a serial poll routine. The serial poll routine determines firstly which device is requesting service and secondly the cause of the service request.

An instrument, such as the 3708A operating on the bus, issues a service request by setting the SRQ line true, and setting bit six in the status byte.

Status Byte

The status byte is the 8 bit data byte returned to the controller after a serial poll. The state of each bit (or the decimal value of the byte) indicates the status of the instrument. Table 6-4 shows the meaning of each bit.

The value of the status byte can be examined at any time by sending the command code "SRQ?" in a data message. The response to the "SRQ?" data message command can then be read into a suitable variable.

```
eg OUTPUT 708 ; "SRQ ?"
   ENTER 708 ; A
   PRINT A
```

The value read into variable A is the sum of the decimal values of the bits set in the Status Byte.

Table 6-4 Status Byte Description

Bit	Decimal Value	Meaning	Comments
0	1	Power Meter zero cal failure, or Self Test Failure	Remains set until cleared by a Device Clear or Selective Device Clear or "CLR" Message.
1	2	Not levelled, due to internal failure, or wrong external filter.	The 3708A is not capable of setting up the required noise power level, due to an internal failure (e.g. internal filter failure or an incompatible level at the input from the external filter path. This indicates too much/little loss in an external filter or too much/ little level for an external Interference tone. The correct level is approx -28dB or a loss of approx 6dB. Self clearing when corrected, also cleared by a Device Clear or Selective Device Clear or "CLR" message.
2	4	Not tracking, due to incompatible settings for this input power.	The level of noise required to be generated exceeds the 3708A capability. This is possible with certain values of carrier power and C/N ratios. This SRQ comes on when the "OUT OF RANGE" indicator is on. It is also used in the Noise Power generation to indicate that the output is not within the ± 0.1 dB limit of the requested level. Self clearing when corrected, also cleared by a Device Clear or Selective Device Clear or "CLR" message.
3	8	Syntax or Programming Error	Did not understand this string. Remains set until cleared by a Device Clear or Selective Device Clear or "CLR" message.

Table 6-4 Status Byte Description (continued)

Bit	Decimal Value	Meaning	Comments
4	16	Calibration sequence, busy	The 3708A is not doing any measurements currently due to a calibration cycle. It is also used in noise bandwidth measurement to show that the result is being processed. Self clearing, also cleared by a Device Clear or Selective Device Clear or "CLR" message.
5	32	Operating mode changed.	Set each time the measurement mode is changed and cleared by first measurement.
6	64	SRQ bit.	Set when instrument asserts SRQ. Cleared when instrument is serial polled, also by a Device Clear or Selective Device Clear or "CLR" message.
7	128	Power Failure	Set at power on. Remains set until cleared by a Device Clear or Selective Device Clear or a "CLR" message.

SRQ Mask

The 3708A has the flexibility to issue a service request for any combination of conditions listed in Table 6-4. Once it has been decided which conditions warrant a service request the SRQ mask can be set. This is done by adding together the decimal values corresponding to the bits which are to be set. This value N is then sent in the data message as follows

"SRQ MASK N ENT" or "SRQ MASK", N "ENT"

At power on the instrument defaults to set the SRQ mask to 255.

NOTE: Bit 7 in the status register is set at power on and since the SRQ defaults to 255, this means that an SRQ is produced at every power on.

SRQ On/Off

The 3708A can be prevented from issuing service requests by sending the following command code in the data message.

"RQS OFF"

To re-issue service requests send

"RQS ON"

The service request control operates independently of the SRQ mask. At power on the instrument defaults to the "RQS ON" condition.

NOTE: Bits in the status register are still set (if the appropriate condition occurs, such as calibration, power fail etc) even though the SRQ mask is set to 0 and the "RQS OFF" condition is set. They can be checked by examining the value of the status byte.

HP-IB Universal Commands

DEVICE CLEAR	TRIGGER
SELECTIVE DEVICE CLEAR	LOCAL
INTERFACE CLEAR	LOCAL LOCKOUT
REMOTE ENABLE	

Device Clear (DCL) and Selective Device Clear (SDC)

These commands are usually sent at the start of a program to reset the instrument and establish known default values throughout the instrument. The default values established are the same as at power on with one exception, at power on the 3708A comes up in the POWER METER mode and an SRQ is asserted due to the power down.

If the instrument is operating in the Noise Generator mode it always defaults to the Noise N measurement. Irrespective of the parameter selected in the Carrier to Noise Mode the 3708A always defaults to C/N. All other modes remain unchanged.

- A DEVICE CLEAR command in HP BASIC using an HP 200 series controller or an HP85 is CLEAR 7 (where the bus I/O select code is 7)
- A SELECTIVE DEVICE CLEAR command in HP Basic using the same controller is CLEAR 708 (where the bus I/O select code is 7 and 08 is the device address).

Table 6-5 Instrument Parameter Default Settings

Carrier to Noise Ratio (C/N)	10dB
Carrier to Noise Density (C/No)	87.7dBHz
Energy per bit to Noise Density (Eb/No)	17.7dB
BIT RATE	10MBit/s
Carrier to Interference (C/I)	10dB
ENTER C	OFF
SYSTEM BW	59.7MHz
TRACK INHIBIT	OFF
Noise Power (N)	-12.3dBm
Noise Density (No)	-90dBm/Hz
NOISE	ON
AVERAGE N	10
INS LOSS ENTER	0
Reference Tone (70/140)	70MHz
NOISE BAND	70±20MHz
ENTER N BW (External Filter)	200MHz
CAL INHIBIT	OFF
SRQ MASK (HP-IB)	255 (all enabled)
RQS ON (HP-IB)	set
ASCII (HP-IB)	set

Interface Clear IFC

The 3708A response to INTERFACE CLEAR is as defined in the IEE 488-1978 specification.

- An IFC command in HP Basic using an HP200 series controller or an HP85 is accomplished by pressing the RESET key or sending.

ABORTIO 7 (HP85)
 ABORT 7 (HP200 SERIES)

Remote Enable (REN)

A REMOTE command directs the 3708A to accept instructions from the bus. When the 3708A receives such a command it illuminates the front panel RMT LED and the front panel is disabled apart from the LOCAL key.

- An example of a REMOTE command in HP Basic using an HP200 series controller or an HP85 is

REMOTE 708 (where the bus I/O select code is 7 and 08 is the device address)

Trigger

The 3708A responds to a TRIGGER command by making a single measurement.

- An example of a TRIGGER command in HP Basic using an HP200 series controller or an HP85 is

TRIGGER 7 or TRIGGER 708

Local

The LOCAL command is used to return the 3708A from a REMOTE condition to local front panel control.

- An example of a LOCAL command using HP basic with an HP200 series or HP85 controller is:

LOCAL 708 (Where the bus I/O select code is 7 and 08 is the device address.
 This returns the instrument to the local mode even if LOCAL
 LOCKOUT is present).

LOCAL 7 (Where the bus I/O select code is 7. This returns the 3708A and
 all other devices on interface 7 to the local mode except when
 LOCAL LOCKOUT is present).

Local Lockout

A LOCAL LOCKOUT command may be sent after the REMOTE command, to disable all the front panel keys including the local key.

- A LOCAL LOCKOUT command in HP BASIC using an HP200 series controller or an HP85.

LOCAL LOCKOUT 7

(Configures all instruments to the LOCAL LOCKOUT condition)

The 3708A Data Message Commands

Data message commands (unique to the 3708A) allow the instrument to be used remotely via HP-IB. The commands fall into two categories.

- KEY ACTION Table 6-6
- FUNCTIONAL/NON-KEY Table 6-7

Note the following tables contain some example statements in HP Basic relating to an HP85 or HP200 series controller. These examples assume that the 3708A has a factory preset address of 8.

Table 6-6 3708A Data Message Commands (Key Action)

Key	HP-IB Code	Modes	Description
AVERAGE N	AVG	POWER METER	Allows the selection of the averaging constant in the Power Meter mode. <i>The default value is 10.</i>
BIT RATE	BIT	Eb/No	Displays the current bit rate and allows entry of a new bit rate. e.g. "BIT 50 ENT". <i>The default bit rate is 10Mbit/sec.</i>
CAL INHIBIT	CAL OFF	ALL	Prevents any calibrations taking place due to temperature changes.
	CAL ON	ALL	Restores the facility to calibrate after a temperature change. This is the default condition.
CANCEL C	CNORM	C/N, C/I, Eb/No, C/No	Cancels the entered value of Carrier power and uses the measured value. <i>This is the default condition.</i>
C/I	CIF	ALL	Enters the Carrier/Interference mode and allows entry of a new ratio value e.g. "CIF 10 ENT". <i>The default value is 10dB.</i>
C/N	CNP	ALL	Enters Carrier/Noise Power mode and allows entry of a new ratio value e.g. "CNP 10 ENT". <i>The default value is 10dB.</i>
C/No	CND	ALL	Enters the Carrier/Noise Density mode and allows entry of a new ratio value e.g. "CND -70 ENT". <i>The default value is -87.7dBHz.</i>
DISP C	DCP or DIP	C/N, C/No, Eb/No, C/I	Displays the current value of carrier power being measured. This value maybe read back via the HP-IB if the "TRG" code is sent.
DISP I	DIF	C/I	Displays the current value of Interference tone at the IF OUTPUT. This value can also be read back via the HP-IB if the "TRG" code is sent.
DISP N	DNP	C/N, C/No, Eb/No	Displays current value of noise power being generated. This value can be read back via the HP-IB if the "TRG" code is sent.

Table 6-6 3708A Data Message Commands (Key Action) continued

Key	HP-IB Code	Mode	Description
DISP No	DND	C/N, C/No, Eb/No	Displays the current value of noise power density being generated. This value can be talked back via the HP-IB if the "TRG" is sent.
Eb/No	EBND	ALL	Enters Energy per bit/Noise Density mode and displays current value. Also allows entry of new value. e.g. "EBND 17 ENT". <i>The default value is -17.7dB</i>
ENTER	ENT	ALL	Must be used when entering numeric data into the 3708A; failure to do so results in a syntax error (flagged via a SRQ). e.g. "CNP 10 ENT".
ENTER C	ENTC	C/N, C/No, Eb/No, C/I	A fixed value of carrier power can be entered instead of measuring it. e.g. "ENTC 5 ENT". This message disables the tracking mode. To cancel this send the code "CNORM".
ENTER N BW	FXBW	NOISE POWER, NOISE DENSITY, C/N, C/No, Eb/No	Displays the noise bandwidth of the external filter and allows entry of a new NBW. e.g. "FXBW 30 ENT". <i>The default value is 200MHz.</i>
INS LOSS ENTER	ILE	ALL	Enters the Noise Bandwidth measurement mode and allows entry of insertion loss of the filter whose bandwidth is to be measured. e.g. "ILE 2.5 ENT". <i>The default value is 0.</i>
INS LOSS MEASURE	ILM	ALL	Measures the insertion loss of a filter connected between the 0dBm REF OUTPUT and the POWER METER INPUT. This result can be read back if the "TRG" code is sent.
INTERNAL	INTBW	ALL	Sets the system noise bandwidth to that of the selected internal filter.
MEAS I	MEASI	C/I	Used in C/I mode. Causes the 3708A to stop tracking and remeasure the level of the incoming Interference tone. Indicates whether, the level is too high/low or suitable then continues in the C/I mode.
N	NPW	ALL	Enters the Noise Generator mode and displays Noise Power. Also allows entry of new value of Noise Power. e.g. "NPW -12 ENT". <i>The default value is -12.3dB.</i>
No	NDE	ALL	Enter the Noise Generator mode and displays Noise Density. Also allows entry of new value of Noise Density. e.g. "NDE -70 ENT". <i>The default value is -90dBm/Hz.</i>
NOISE BAND 70 ± 5	FLT1	NOISE POWER, NOISE DENSITY, C/N, C/No, Eb/No	Selects the 70 ± 5 MHz Noise Band. "ENT" is not necessary. <i>This is the default selection.</i>

Table 6-6 3708A Data Message Commands (Key Action) continued

Key	HP-IB Code	Mode	Description
NOISE BAND 70 ± 20	FLT2	NOISE POWER, NOISE DENSITY, C/N, C/No, Eb/No	Selects the 70 ± 20 Hz Noise Band. "ENT is not necessary".
NOISE BAND 140 ± 40	FLT3		Selects the 140 ± 40 MHz Noise Band "ENT" is not required.
NOISE BAND 10-200	FLT4		Selects the 10-200 MHz Noise Band. "ENT" is not required.
NOISE BW MEASURE	NBWM	NOISE BANDWIDTH	Measures the Noise Bandwidth of the filter connected between the POWER METER Input and NOISE OUTPUT. This value can be read back after the "TRG" code is sent.
NOISE OFF	NOISE OFF	NOISE POWER, NOISE DENSITY, C/N, C/No, Eb/No	Switches Noise off
NOISE ON	NOISE ON	NOISE POWER, NOISE DENSITY, C/N, C/No, Eb/No	Switches Noise on. <i>This is the default condition.</i>
POWER METER	IPW	ALL	Enters the Power Meter mode and measures the power at the POWER METER input. This value can be read back after sending the "TRG" code.
POWER METER ZERO	ZERO	POWER METER	This forces the Power Meter to read the 0dBm reference (which must be connected to the POWER METER input) and zero the Power Meter. If the measured value is not within ± 1 dB the Power Meter does not zero and bit 0 in the status byte is set. Accordingly if the SRQ mask has this bit set, a SRQ is generated.
REFERENCE (70MHz)	REF 1	ALL	Sets the Reference frequency to 70MHz. <i>This is the default condition.</i>
REFERENCE (140MHz)	REF 2	ALL	Sets the Reference frequency to 140MHz.
SELECT (EXT FILTER)	FLT 5	NOISE POWER, NOISE DENSITY, C/N, C/No, Eb/No	Selects EXT FILTER noiseband. <i>NOTE:- ENT is not required.</i>
SELF TEST	TST 0	ALL	Performs self test 0
	TST 1	ALL	Performs self test 1
	TST 2	ALL	Performs self test 2
	TST 3	ALL	Performs self test 3
SYSTEM BW	NBW	C/N	Allows entry of the noise bandwidth of a radio system (or item under test).
TRACK INHIBIT	TRACK OFF	C/N, C/No, Eb/No, C/I	Disables the tracking mode.

Table 6-6 3708A Data Message Commands (Key Action) continued

Key	HP-IB Code	Mode	Description
TRANS N BW	TRACK ON	C/N, C/No, Eb/No, C/I	Enables the tracking mode. <i>This is the default condition.</i>
	XBW	C/N, C/No, Eb/No, NOISE POWER, NOISE DENSITY, NOISE BANDWIDTH	Transfers the noise bandwidth of the measured noise bandwidth to that associated with the external filter.

Table 6-7 3708A Data Message Commands (Functional)

Function	HP-IB Code	Mode	Description
ASCII MODE	ASC	ALL	The measured results are returned as an ASCII string. e.g. IPW -20.00, 0. <i>This ASCII mode is the default condition.</i>
BINARY MODE	BIN	ALL	Allows fast data transfer of measurement results. An example program is shown below. <pre> 10 Z=708 20 OUTPUT Z;"bin " 30 TRIGGER Z 40 ENTER Z USING "#,W";A,B 50 DISP A/100 60 GOTO 30 70 END </pre>
CLEAR	CLR	ALL	Clears the service request register, setting all bits to zero.
END OR IDENTIFY OFF	EOI OFF	ALL	Prevents the 3708A sending EOI after the last data byte.
END OR IDENTIFY ON	EOI ON	ALL	Includes EOI with last data bytes. <i>This is the default condition.</i>
ERRORS-SELF TEST	ERR?	ALL	Only effective after a Self Test. Allows reading of the self test register which contains 0 if the tests passed or the number of the first test that failed.
IDENTIFY	ID?	ALL	Allows reading of the instrument name. Result is of the form :- HP3708 A
NOISE BANDWIDTH	NBW?		This returns the value of the noise bandwidth currently in use. <i>Note: The TRG code is not required.</i>

Table 6-7 3708A Data Message Commands (Functional) continued

Function	HP-IB Code	Mode	Description
POWER METER AUTORANGE	RNG0	POWER METER	Allows the power meter to autorange. <i>This is the default condition.</i>
POWER METER RANGE 1	RNG1	POWER METER	Sets a fixed 0dB attenuation in the power meter path.
POWER METER RANGE 2	RNG2	POWER METER	Sets a fixed 5dB attenuation in the power meter path.
POWER METER RANGE 3	RNG3	POWER METER	Sets a fixed 10dB attenuation in the power meter path.
POWER METER RANGE 4	RNG4	POWER METER	Sets a fixed 15dB attenuation in the power meter path.
POWER METER RANGE 5	RNG5	POWER METER	Sets a fixed 20dB attenuation in the power meter path.
POWER METER RANGE 6	RNG 6	POWER METER	Sets a fixed 25dB attenuation in the power meter path.
POWER METER RANGE 7	RNG 7	POWER METER	Sets a fixed 30dB attenuation in the power meter path.
POWER METER RANGE 8	RNG 8	POWER METER	Sets a fixed 35dB attenuation in the power meter path.
RESET	RST	ALL	The instrument performs a reset sequence. The same as for a Device Clear or Selective Device Clear and the instrument parameters assume the default settings outlined on Page 56.
REV number of instrument	REV?	ALL	On receipt of this code the 3708A returns the software revision followed by a 0. The returned data can be entered into two variables.e.g. OUTPUT 708; "REV?" ENTER 708; A,B <i>NOTE:- The "TRG" code is not required.</i>
SERIAL NUMBER	SER?	ALL	On receipt of this code the 3708A returns the instrument serial number in the form of an alpha string (1213U00001). The returned data can be entered into a suitable string variable. e.g. OUTPUT 708; "SER?" ENTER 708; A\$ <i>NOTE:- The "TRG" code is not required.</i>
SERVICE REQUEST ENABLE	RQS ON	ALL	Enables the pulling of the SRQ line, whether or not bit 6 is set in the SRQ mask.
DISABLE	RQS OFF	ALL	Disables the pulling of the SRQ line irrespective of the state of the SRQ mask.

Table 6-7 Data Message Commands (Functional) continued

Function	HP-IB Code	Mode	Description																											
SRQ byte status	SRQ?	ALL	Returns the value of the serial poll register. This allows the controller to examine the value of the status byte without carrying out a serial poll sequence.																											
SERVICE REQUEST MASK	SRQ MASK	ALL	<p>The Service Request Mask feature in the 3708A allows the user to program the instrument to provide an SRQ to the HP-IB controller when specific conditions, determined by the operator, exist. The following table summarizes the conditions and give the decimal value.</p> <table border="1"> <thead> <tr> <th>Bit#</th> <th>Decimal</th> <th>SRQ Condition enabled</th> </tr> </thead> <tbody> <tr> <td>0</td> <td>1</td> <td>Self Test or Power Meter cal fail</td> </tr> <tr> <td>1</td> <td>2</td> <td>Not levelled</td> </tr> <tr> <td>2</td> <td>4</td> <td>Not tracking</td> </tr> <tr> <td>3</td> <td>8</td> <td>Syntax or programming error</td> </tr> <tr> <td>4</td> <td>16</td> <td>Calibrating, busy</td> </tr> <tr> <td>5</td> <td>32</td> <td>Operating mode changed</td> </tr> <tr> <td>6</td> <td>64</td> <td>SRQ bit</td> </tr> <tr> <td>7</td> <td>128</td> <td>Power Fail</td> </tr> </tbody> </table> <p>e.g. to set the mask with all bits set OUTPUT 708; "SRQ MASK 255 "ENT"</p> <p>NOTE 1:- The mask is reset to the default value (255) at power on, on receipt of a Device Clear, Selective Service Device, or with the "RST" code.</p> <p>NOTE 2:- A SRQ is always produced by a power fail irrespective of the mask setting.</p> <p>NOTE 3:- The "RQS ON", "RQS OFF" override the setting of bit 6 in the mask.</p>	Bit#	Decimal	SRQ Condition enabled	0	1	Self Test or Power Meter cal fail	1	2	Not levelled	2	4	Not tracking	3	8	Syntax or programming error	4	16	Calibrating, busy	5	32	Operating mode changed	6	64	SRQ bit	7	128	Power Fail
Bit#	Decimal	SRQ Condition enabled																												
0	1	Self Test or Power Meter cal fail																												
1	2	Not levelled																												
2	4	Not tracking																												
3	8	Syntax or programming error																												
4	16	Calibrating, busy																												
5	32	Operating mode changed																												
6	64	SRQ bit																												
7	128	Power Fail																												
TRIGGER	TRG		<p>Makes the last measurement result available for HP-IB. The "TRG" code must precede any attempt to read results back from the 3708A.</p> <p>e.g. If the instrument is configured in the Power Meter mode send OUTPUT 708; "TRG" ENTER 708; A</p>																											
The following HP-IB MNEMONICS are reserved for service use only.																														
DATA READ	DRD	SOFT	<p>Used in SOFT program. Allows reading of a specific soft constant.</p> <p>e.g. OUTPUT 708; "DRD 1 ENT" ENTER 708; A (A has a value of constant 1)</p>																											

Table 6-7 Data Message Commands (Functional) continued

Function	HP-IB Code	Mode	Description
DATA WRITE	DWR	SOFT	Used in SOFT program. Allows writing of a specific soft constant. e.g OUTPUT 708; "DWR 1 ENT 77.4 ENT" Where 1 is the soft constant number and 77.4 is the constant value.
FREEZE INSTRUMENT STATUS	FREZE	ALL	Freezes the hardware state of the instrument, therefore disabling measurements.
PORT READ	PRD	SOFT	Used in SOFT program. Allows reading of a particular port. e.g. To read value at port 10. OUTPUT 708 "PRD 10 ENT" ENTER 708; A
PORT WRITE	PWR	SOFT	Used in SOFT program. Allows writing to a particular port. "PWR 2 ENT 64 ENT" Where 2 is the port number and 64 is the written value.
SOFT CONSTANTS ACCESS	SOFT	ALL	Exits normal measurement modes and allows use of PRD/PWR, DRD/DWR. Exited by calling for any normal measurement mode.
THAW INSTRUMENT STATUS	THAW	ALL EXCEPT SOFT	Restarts measurements that have been previously frozen -see FREEZE

Sample Program

The following program written in HP BASIC for an HP85B desk top computer illustrates how to run the instrument self tests remotely, and make a power measurement. The program is included to give a guide mainly to structure and syntax. (it is not intended as a user program). In many cases the instrument will be used as a stimulus and most of the HP-IB messages sent to the instrument will usually be configuration instructions setting up defined levels - *the instrument can be regarded as a generator of defined signal levels and ratios (see Simple Programs page 52 for some further programming steps).*

```

5 CLEAR
10 DISP "WHAT IS THE 3708 ADDRESS "
20 INPUT Z
30 IF Z<31 THEN Z=Z+700
40 OUTPUT Z ;"CLR"
45 N=0
49 !
50 ! ENABLE SERIAL POLL
60 ON INTR 7 GOSUB 1000
70 ENABLE INTR 7;8
80 !
90 !
200 ! ***** SELF TESTS *****
210 CLEAR @ DISP "CONNECT THE ODBM REF OUTPUT TO THE POWER METER INPUT -- PRESS CONT"
220 PAUSE
230 OUTPUT Z ;"TST0"
240 WAIT 2000
250 CLEAR @ DISP "CONNECT THE NOISE OUTPUT TO THE POWER METER INPUT"
251 DISP "LINK THE EXTERNAL FILTER PORTS BY MEANS OF A SHORT CABLE--PRESS CONT"
255 PAUSE
260 OUTPUT Z ;"TST1" @ WAIT 32000
270 CLEAR @ DISP "LINK THE ODBM REF OUTPUT TO THE IF INPUT"
271 DISP ""
272 DISP "LINK THE IF OUTPUT TO THE POWER METER INPUT--PRESS CONT"
280 PAUSE
290 OUTPUT Z ;"TST2"
300 WAIT 2000
310 CLEAR @ DISP "LINK THE ODBM REF OUTPUT TO THE REAR PANEL AUX INTERFERER INPUT"
311 DISP ""
312 DISP "LINK THE IF OUTPUT TO THE POWER METER INPUT-- PRESS CONT"
320 PAUSE
330 OUTPUT Z ;"TST3" @ WAIT 2000
340 CLEAR
350 IF N=0 THEN PRINT "PASSED SELF TESTS"
360 !
370 !
500 ! *** POWER MEASUREMENT ***
510 OUTPUT Z ;"IFW,TRG"
520 CLEAR @ DISP "SETTLING"
521 WAIT 500
530 ENTER Z ; A,B
540 IF B>0 THEN PRINT "POWER LEVEL OUT OF RANGE"
550 PRINT USING "K,3X,K" ; "POWER LEVEL",A,"dBm"
555 CLEAR
570 GOTO 3000
998 !
999 !
1000 ! ***** SERIAL POLL *****
1010 STATUS 7,1 ; S
1020 S=SPOLL(Z)
1030 IF BIT(S,0)=1 THEN GOSUB 1500
1040 IF BIT(S,1)=1 THEN PRINT "3708 NOT LEVELLED"
1050 IF BIT(S,2)=1 THEN PRINT "3708 NOT TRACKING OR OUT OF RANGE"
1060 IF BIT(S,3)=1 THEN PRINT "PROGRAM ERROR"
1070 IF BIT(S,4)=1 THEN PRINT "3708 CALIBRATING PLEASE WAIT"
1080 IF BIT(S,7)=1 THEN GOTO 2000

```



```
1090 ENABLE INTR 7;8
1100 RETURN
1110 !
1120 !
1499 ! *** SELF TEST ERROR *****
1500 OUTPUT Z ;"ERR?"
1510 ENTER Z ; A
1520 IF A>0 THEN PRINT "TEST ";A;"FAILED"
1530 N=1
1540 RETURN
1550 !
1560 !
2000 PRINT "POWER FAILURE"
2010 GOTO 40
3000 END
```

Note a list of Self Test error codes are given in Appendix C.

This program can be adapted for use on HP200 series computers by changing the following:

```
70 ENABLE INTR 7;2
1010 STATUS 7,4;S
```

The WAIT statements, in the program for the HP85 are in milliseconds, are necessary to allow time for the various self tests to be carried out and for the Power Meter to settle. In the HP200 series computers the WAIT statements are in seconds, and may require lengthening by 0.1 seconds to accommodate for the differences in computational speeds.

All "CLEAR @" and "@ WAIT" statements should also be deleted. The WAIT statement should go in a separate line.

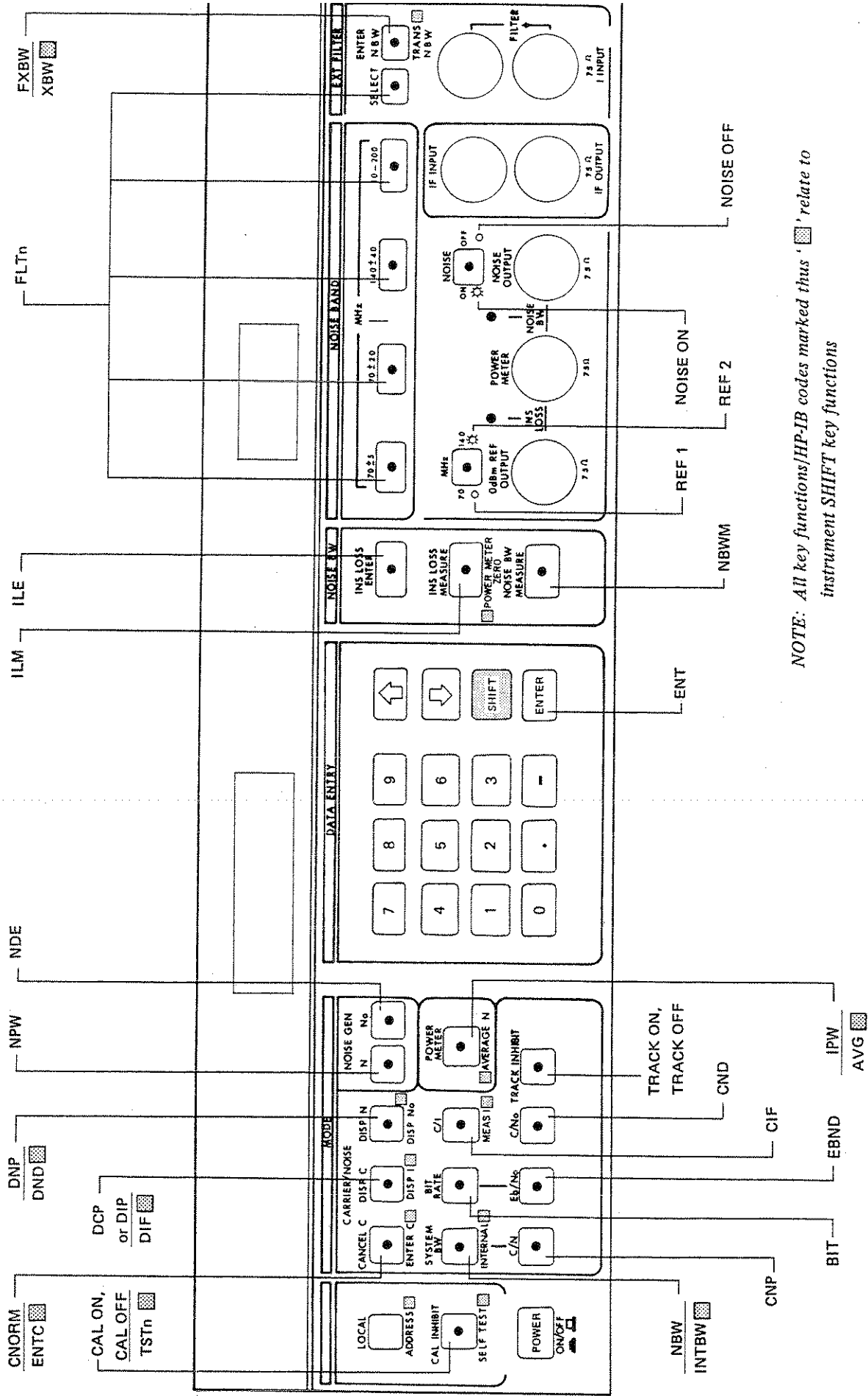

NOTE: All key functions/HP-IB codes marked thus ' [] ' relate to instrument SHIFT key functions

Figure 6-2 Basic Operation — HP-IB Codes

7 GENERAL INFORMATION

Introduction

On the title page of this manual is a Microfiche Part Number. This number can be used to order 4 x 6 inch microfilm transparencies of the manual. Each microfiche contains up to 96 photo duplicates of the manual pages. A service manual is also supplied with each instrument which contains the information necessary to maintain and repair the 3708A.

Specification

Instrument specifications are listed in Table 7-1. These specifications are the performance standards or limits against which the instrument is tested.

Safety Consideration

This product is a Safety Class B instrument (provided with a protective earth terminal). The instrument and manual should be reviewed for safety markings and instructions before operation. Also read the Warning on Page ii.

Instruments Covered by Manual

Attached to the instrument is a serial number plate. This serial number is in the form XXXXUXXXXX. It is in two parts; the first four digits and the letter are the serial prefix and the last five are the suffix. The prefix is the same for all identical instruments, it changes only when a change is made to the instrument. The suffix however, is assigned sequentially and is different for each instrument. The contents of this manual apply to instruments with the serial number prefix(es) listed under SERIAL NUMBERS on the title page.

An instrument manufactured after the printing of this manual may have a serial number prefix that is not listed on the title page. This unlisted serial number prefix indicates that the instrument is different from those described in this manual. The manual for this new instrument is accompanied by a manual changes supplement. This supplement contains "change information" that explains how to adapt the manual to the newer instrument.

In addition to change information, the supplement may contain information for correcting errors in the manual. To keep this manual as current and accurate as possible, Hewlett-Packard recommends that you periodically request the latest Manual Changes supplement. The supplement for this manual is identified with the manual print date and part number, both of which appear on the manual title page. Complimentary copies of the supplement are available from Hewlett-Packard.

For information concerning a serial number prefix that is not listed on the title page or in the Manual Changes supplement, contact your nearest Hewlett-Packard office.

Description

The 3708A Noise and Interference Test Set is designed for operation in the IF section of a digital or FM radio, where it will add calibrated levels of white noise and/or interference signals to the radio IF carrier.

A built in power meter and microprocessor control enable constant carrier to noise (or carrier to interference) ratios to be maintained at the injection point, regardless of radio carrier power variations.

The 3708A can be used effectively to simplify performance testing in;

- (a) Digital radio systems
- (b) FDM/FM microwave radio links
- (c) Satellite TDMA ground stations
- (d) Secure communication systems

The main features of the 3708A are;

- (a) Noise Source - a value of noise can be selected and the 3708A will generate it accurately and it is available at the NOISE OUTPUT port.
- (b) Tracking Mode - This enables the 3708A to maintain selected C/N or C/I ratios with a variable carrier.
- (c) Power Meter - measures the received IF power and gives an accurate display on the front panel.
- (d) Reference Tone - provides a high stability, accurate OdBm level at the OdBm REF OUTPUT.
- (e) Noise Bandwidth Measurement - the 3708A can directly measure the radio IF filter noise bandwidth.
- (f) Full HP-IB Programmability - all functions in the 3708A are available under remote calculator control.

Accessories Supplied

The accessories supplied with the 3708A are listed below.

- (a) The line power cable is supplied in one of six configurations depending upon the country of destination of the instrument (*see Power Cables on Page 76*).
- (b) A 200mm calibration cable.
- (c) The following manuals are supplied with each instrument.
 - (1) Service Manual HP03708-90000
 - (2) Operating Manual HP03708-90001

Options

The following option is available with the 3708A.

OPTION 001 - The input/output 75 ohm connectors are substituted with 50 ohm connectors.

Table 7-1 Specifications

Except where otherwise indicated, the following parameters are warranted performance specifications. Parameters described as "typical" or "nominal" are supplemental characteristics which provide a useful indication of typical, but non-warranted performance characteristics. All specifications are guaranteed over an ambient temperature of 0° to 55°C, except where otherwise stated.

NOISE GENERATION

Band-limited white noise, available as "noise only" (Noise Output connector) or as "noise + carrier" (IF Output connector).

Level range of noise

At Noise Output connector (max output 6 dB lower at IF Output).

+6 to -80 dBm (filter-dependent, see table below);
 -70 dBm/Hz (filter-dependent, see table below) to
 -154 dBm/Hz.

Absolute accuracy of noise power

(Noise Output connector)

After calibration of power meter with the 0 dBm reference tone (70 or 140 MHz).

± 0.25 dB in range +6 to -10 dBm output power at 23 ± 3°C;

± 0.5 dB in range +6 to -55 dBm output power.

Band-limiting filters

The noise bandwidth of each instrument filter set is individually measured and stored in non-volatile memory. Values given below are typical and individual instruments will show different values on the front panel display.

Noise bandwidth accuracy: ± 0.15 dB ± 2.5%.

Frequency Bands (MHz)	Flatness (wrt centre frequency) (dB)	Noise Bandwidth* (MHz)	Typical Temperature Stability (dB/°C)	Max No* (dBm/Hz)	Min N* (dBm)
70 ± 5	± 0.3	18	0.001	-67	-81
70 ± 20	± 0.4	60	0.001	-72	-76
140 ± 40	± 0.5	125	0.001	-75	-73
10 to 200	± 0.8	215	0.0015	-78	-70

*Nominal values, will vary for individual instruments.

Crest factor

Typically ≥ 15 dB.

C/N power ratio (IF Output connector)

Range: -10 to 60 dB.

Accuracy:

Over range C = +1 to -5 dBm, C/N = 10 to 30 dB, 23 ± 3°C.

± 0.3 dB for 70 ± 20 MHz filter;

± 0.35 dB for 140 ± 40 MHz filter.

Over range C = +5 to -40 dBm, N = 0 to -45 dBm, C/N = 0 to 40 dB.

± 0.5 dB for all filters.

Typical results as shown in graph below.

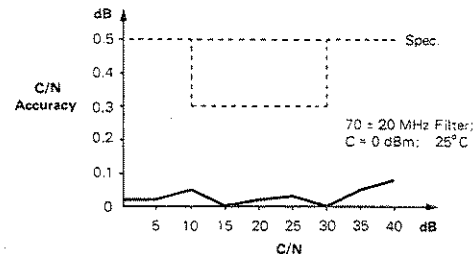

Response time (tracking speed)

Typically 10 ms for a carrier power change ≤ ± 5 dB.

INTERFERENCE SIGNAL INPUTS

The HP 3708A offers two distinct facilities for interference tests. Both are broadband inputs, with a frequency range of 10 to 200 MHz.

AUXILIARY INTERFERER INPUT (rear panel)

Provides a fixed-loss path to the IF Output (but not to the Noise Output).

Flatness

70 ± 20 MHz: ± 0.2 dB with respect to 70 MHz.

140 ± 40 MHz: ± 0.6 dB with respect to 140 MHz.

Loss to IF Output

Typically 15 dB.

INTERFERER (I) INPUT (front panel, common to Ext Filter Input)

Valid interferer input power

-30 dBm typical (indicated by I Level lamps on front panel).

C/I power ratio

Range: -10 to 60 dB.

Accuracy:

Over range C = +1 to -5 dBm, C/I = 10 to 30 dB, $23 \pm 3^\circ\text{C}$.

± 0.3 dB for 70 ± 10 MHz interferer;

± 0.35 dB for 140 ± 10 MHz interferer.

Over range C = +5 to -40 dBm, I = 0 to -45 dBm, C/I = 0 to 40 dB.

± 0.5 dB for interferer tone 70 ± 20 MHz;

± 0.6 dB for interferer tone 140 ± 40 MHz.

Typical results as shown in graph below

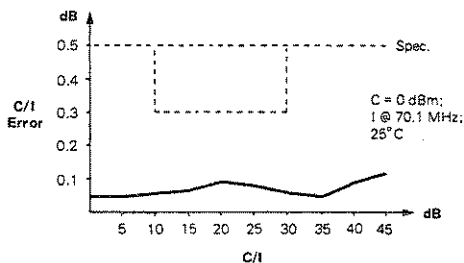

Flatness of interference path

70 ± 5 MHz: ± 0.1 dB with respect to 70 MHz.

70 ± 20 MHz: ± 0.4 dB with respect to 70 MHz.

140 ± 40 MHz: ± 0.4 dB with respect to 140 MHz

10 to 200 MHz: 1 dB pk-pk

Response time

Typically 10 ms for a carrier power change ± 5 dB.

CARRIER PATH

The carrier path is specified from IF Input to IF Output.

Gain (at 70 MHz)

0 ± 0.4 dB (typically 0 ± 0.1 dB).

Flatness

70 ± 20 MHz: ± 0.2 dB with respect to 70 MHz (typically ± 0.1 dB).

140 ± 40 MHz: ± 0.3 dB with respect to 140 MHz (typically ± 0.1 dB).

Group delay

0.2 ns for ranges 70 ± 20 MHz, 140 ± 40 MHz.

3rd order intercept point

Typically +29 dBm.

POWER MEASUREMENT

Specifications apply to Power Meter input only.

Measurement range

+6 to -55 dBm.

Absolute Accuracy

± 0.3 dB at 0 dBm, 70 MHz;

(± 0.15 dB at 0 dBm, $23 \pm 3^\circ\text{C}$, 70/140 MHz after calibration using reference tone - see below).

Flatness

10 to 180 MHz: ± 0.3 dB with respect to 70 MHz.

Resolution

0.01 dB.

Linearity

Measured at 70 MHz.

+5 to -35 dBm: ± 0.1 dB (typically ± 0.05 dB).

-35 to -45 dBm: ± 0.3 dB.

REFERENCE TONE OUTPUT

Frequency

70/140 MHz crystal-controlled oscillator, front-panel selectable. Other frequencies available on special order.

Level

0 dBm ± 0.15 dB.

Factory-set to 0 dBm ± 0.05 dB at $23 \pm 3^\circ\text{C}$.

Harmonic content

< -25 dBc.

INSERTION LOSS MEASUREMENT

Accuracy

± 0.2 dB at 70 or 140 MHz.

Range

-5 to 35 dB.

NOISE BANDWIDTH MEASUREMENT

Accuracy

$\pm 0.4 \text{ dB} \pm 10\%$ (includes insertion loss measurement accuracy of $\pm 0.2 \text{ dB}$).

Range

Function of insertion loss and filter bandwidth, see graph:-

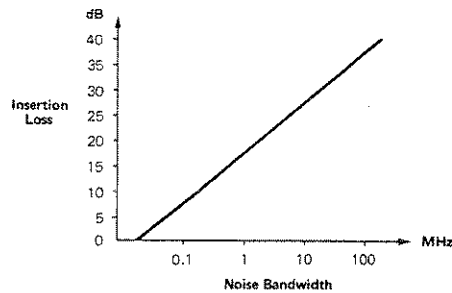

HP-IB FACILITIES

Mode

Addressable; factory-preset address 8, selected by rear-panel switch.

Load

One bus load.

Local switch

Allows switching from remote to local control, except when controller has issued a local lockout command.

Interface functions subset

SH1, AH1, T6, L4, SR1, RL1, PP0, DC1, DT1, C0.

have a return loss $> 26 \text{ dB}$ (except the rear-panel Aux Interferer input, with a return loss of 18 dB, typically).

Power supply

Input voltages: 100/120/220/240V ac.

Tolerance: +5 to -10%.

Frequency: 48 to 66 Hz.

Power consumption: 150VA max.

Dimensions (including connectors and feet)

145mm (5.75 in) high; 425 mm (16.75 in) wide;

540 mm (21.2 in) deep.

Weight

16 kg (35 lb), net; 29 kg (63 lb), shipping.

GENERAL

Connectors

All signal connectors in the HP 3708A are BNC type and

Environment

0° to 55° C operating; -40° to 75° C, storage.

OPTIONS

In the HP 3708A standard instrument, all signal connectors impedances are 75Ω nominal, unbal to gnd. Reference tone oscillator frequency is 70/140 MHz, selectable from the front panel. Reference tone oscillator frequencies other than the standard values are available on a special order basis.

001: CONNECTORS: all signal connectors impedances are 50Ω nominal, unbal to gnd.

801: PROTECTIVE FRONT COVER.

907: FRONT HANDLE KIT: adds front handles to the HP 3708A. Options 801 and 907 cannot be fitted at the same time.

908: RACK FLANGE KIT: enables the HP 3708A to be secured in a 483 mm (19 in) rack.

909: RACK AND HANDLE KIT: combination of Options 907 and 908.

910: EXTRA SET OF MANUALS.

8 INSTALLATION

Introduction

This section provides installation instructions for the Hewlett-Packard Model 3708A Noise and Interference Test Set and its accessories. This section also includes information about initial inspection and damage claims, preparation for using and packaging, storage and shipment.

Initial Inspection

WARNING

TO AVOID HAZARDOUS ELECTRICAL SHOCK, DO NOT PERFORM ELECTRICAL TESTS WHEN THERE ARE SIGNS OF SHIPPING DAMAGE TO ANY PORTION OF THE OUTER ENCLOSURE (COVERS, PANELS, METERS).

Inspect the shipping container for damage. If the shipping container or cushioning material is damaged, it should be kept until the contents of the shipment have been checked for completeness and the instrument has been checked mechanically and electrically. Procedures for checking electrical performance are given in Section IV of the Service Manual. If the contents are incomplete, if there is mechanical damage or defect or if the 3708A does not pass the Performance Tests, notify the nearest Hewlett-Packard office. If the shipping container is damaged or the cushioning material shows signs of stress, notify the carrier as well as the Hewlett-Packard office. Keep the shipping materials for the carriers inspection. The HP office will arrange for repair or replacement at HP Option without waiting for claim settlement.

WARNING

TO AVOID THE POSSIBILITY OF INJURY OR DEATH, THE FOLLOWING PRECAUTIONS MUST BE FOLLOWED BEFORE THE INSTRUMENT IS SWITCHED ON.

- (A) NOTE THAT THE PROTECTION PROVIDED BY GROUNDING THE INSTRUMENT CABINET MAY BE LOST IF ANY POWER CABLE OTHER THAN THE THREE-PRONGED TYPE SUPPLIED IS USED TO COUPLE THE AC LINE VOLTAGE TO THE INSTRUMENT.
- (B) IF THIS INSTRUMENT IS TO BE ENERGIZED VIA AN AUTO-TRANSFORMER TO REDUCE OR INCREASE THE LINE VOLTAGE, MAKE SURE THAT THE COMMON TERMINAL IS CONNECTED TO THE NEUTRAL POLE OF THE POWER SOURCE.

- (C) THE POWER CABLE PLUG SHALL ONLY BE INSERTED INTO A SOCKET OUTLET PROVIDED WITH A PROTECTIVE EARTH CONTACT. THE PROTECTIVE ACTION MUST NOT BE NEGATED BY THE USE OF AN EXTENSION CORD WITHOUT A PROTECTIVE CONDUCTOR (GROUNDING).

Power Requirements

The 3708A requires a power source of 100V, 120V, 220V, or 240V ac, +5%-10%, 48 to 68Hz single phase. The maximum power consumption is 100VA.

Line Voltage Selection and Fuse

The line voltage is selected by the rear panel switch labelled 100V, 120V, 220V and 240V.

CAUTION

Before connecting the instrument to a power outlet ensure that the line voltage selector is correctly set, and that a fuse of the correct rating is fitted.

Table 8-1 Fuses

Nominal Line	Fuse Rating	HP Part Number
100V 120V	2A	2110-0303
220V 240V	1A	2110-0007

Power Cable

This instrument is equipped with a three-wire power cable. When connected to a power outlet, this cable grounds the instrument case. The type of power cable shipped with each instrument depends on the country of destination. Refer to Figure 8-1 for part numbers of the power cable and plug configurations available. The number shown below each plug is the Hewlett-Packard part number of a power cord equipped with that plug. If the appropriate power cord is not included with the instrument, notify the nearest Hewlett-Packard Sales and Service Office and a replacement will be provided.

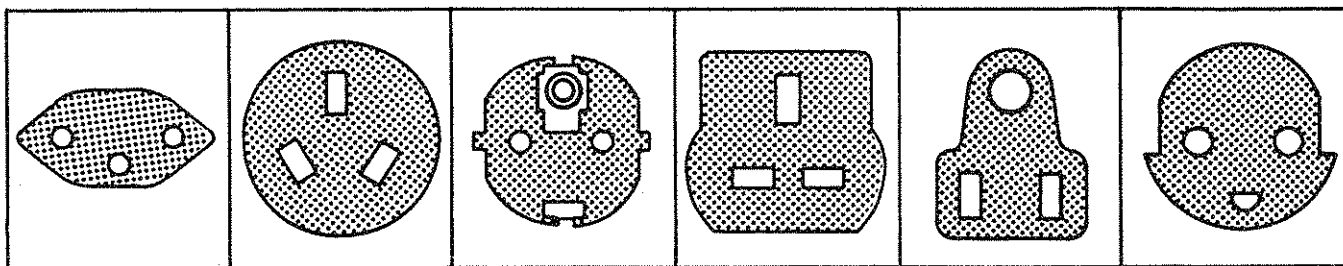

Figure 8-1 Power Receptacles

The colour code used in each power cable is given below:

Line	Brown
Neutral	Blue
Ground	Green/Yellow

Operating Environment

Temperature - The instrument may be operated in temperatures from 0 degrees centigrade to +55 degrees centigrade.

Humidity - The instrument should be protected from temperature extremes which may cause condensation within the instrument.

Altitude - The instrument may be operated at altitudes up to 4600m (15,000ft).

Rack Mounting

The 3708A is packaged in a free-standing case with plastic feet. If desired the 3708A may be rack mounted. Rack mount kits which contain full instructions may be obtained from Hewlett-Packard. If required front handle kits may be obtained.

Rack Mount Kit	HP Part No 5061-0077
Front Handle Kit	HP Part No 5061-0089
Front Handle & Rack Mount Kit	HP Part No 5061-0083

Storage and Shipment

Environment

The instrument may be stored or shipped in environments within the following limits:

Temperature -40 degrees centigrade to +75 degrees centigrade
Altitude 15,300m (50,000ft)

The instrument should also be protected from temperature extremes which may cause condensation within the instrument.

Packaging

Tagging for service - If the instrument is being returned to Hewlett-Packard for service, please complete one of the blue repair tags located at the front of the service manual and attach it to the instrument.

Original Packaging - Containers and material identical to those used in the factory packaging are available through Hewlett-Packard offices. If the instrument is being returned to Hewlett-Packard for servicing, attach a tag indicating the type of service required, return address, model number, and full serial number. Also mark the container "FRAGILE" to ensure careful handling. In any correspondence, refer to the instrument by model number and full serial number.

Other Packaging - The following general instructions should be used for re-packing with commercially available materials:

- (a) Wrap instrument in heavy paper or plastic. (If shipping to Hewlett-Packard office or service centre, attach a tag indicating type of service required, return address, model number and full serial number.)
- (b) Use strong shipping container. A double-walled carton made of 350-pound test material is adequate.
- (c) Use a layer of shock absorbing material 70 to 100mm (3- to 4-inch) thick around all sides of the instrument to provide firm cushioning and prevent movement inside the container. Protect the control panel with cardboard.
- (d) Seal shipping container securely.
- (e) Mark the shipping container "FRAGILE" to ensure careful handling.
- (f) In any correspondence, refer to instrument by model number and full serial number.

HEWLETT-PACKARD INTERFACE BUS (HP-IB) INSTALLATION

This section contains information and instructions on the installation of the 3708A Noise and Interference Test Set into a Hewlett-Packard Interface Bus (HP-IB) system.

The HP-IB is Hewlett-Packard's implementation of the IEEE Standard 488-1978 (Digital Interface for Programmable Instrumentation). This standard defines a physical interface and protocol which enables the remote control of instrumentation systems.

Connection to the HP-IB

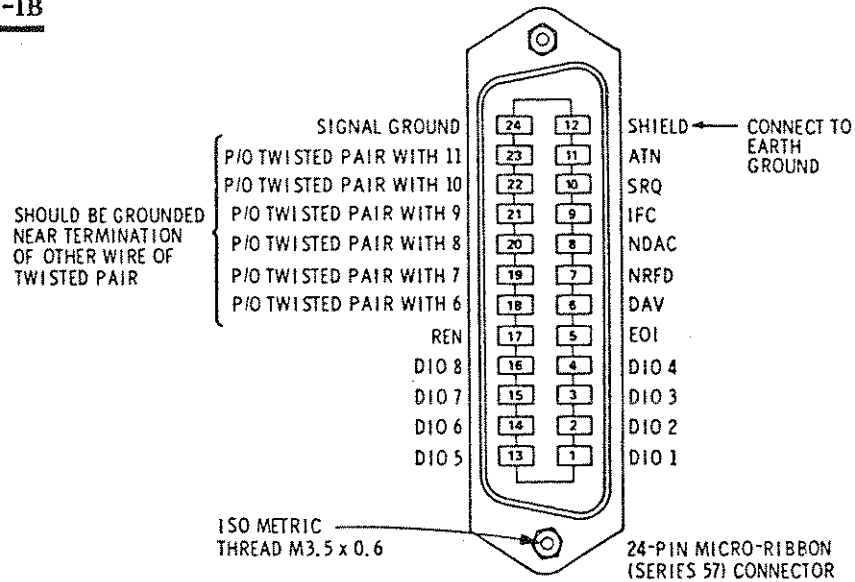

Figure 8-2 HP-IB (rear panel) Connector

The HP-IB connector on the rear panel of the 3708A provides the physical interface to connect the 3708A into an HP-IB system. Figure 8-2 illustrates the connector pin configuration.

HP-IB Cables

Devices in the HP-IB system may be interconnected in any suitable arrangement (star, delta etc) using the HP-IB cables listed in Table 8-2 provided the following restrictions are obeyed.

Table 8-2 HP-IB Interface Cables

HP-IB Part Numbers	Cable Lengths
HP 10833A	1 metre (3.3ft)
HP 10833B	2 metres (6.6ft)
HP 10833C	4 metres (13.2ft)
HP 10833D	0.5 metres (1.6ft)

To achieve design performance, restrictions are placed on the length of HP-IB system cable as follows:

1. The total length of HP-IB cable used to interconnect devices on the HP-IB must not exceed 2 metres (6.6ft) times the number of devices in the system.
2. The maximum accumulative length of HP-IB cable for any HP-IB cable for any HP-IB system is 20 metres (65.6ft).

HP-IB Address Switch

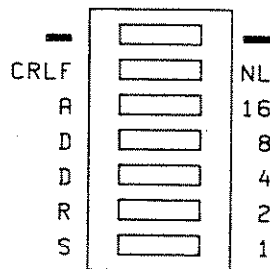

Figure 8-3 Address Switch

ADDRS 1,2,4,8 & 16

These five switch positions shown in Figure 8-3 allow the 3708A HP-IB address to be set to the addresses outlined in Table 8-3. The 3708A is factory preset to address decimal 8.

CR/LF NL

The setting of the CR/LF NL switch determines whether data transfer messages (results) returned from the 3708A to the system controller are terminated by the ASCII carriage return line feed CR/LF character or new line NL character. The instrument is factory preset to the CR/LF position.

The 3708A monitors the address switch setting **ONLY** at switch on. When the front panel HP-IB ADDRESS key is pressed, the displayed address is the result of a read from memory, not the switch ie it reads the address entered into memory at switch on. If the instrument address is changed while the instrument is running, this will not be entered into memory until the instrument has been switched OFF and then ON.

Table 8-3 HP-IB Addresses

Device	Talk	Listen
0	@	SP
1	A	!
2	B	"
3	C	6 #
4	D	\$
5	E	%
6	F	&
7	G	'
8	H	([☆]
9	I)
10	J	*
11	K	+
12	L	,
13	M	-
14	N	.
15	O	/
16	P	0
17	Q	1
18	R	2
19	S	3
20	T	4
21	U	5 [★]
22	V	6
23	W	7
24	X	8
25	Y	9
26	Z	:
27	[;
28	\	<
29]	=
30	-	>

☆ 3708A Factory Preset Address

★ Usually HP Desk Top Controller Preset Address

APPENDIX A

SYSTEM BANDWIDTH

The SYSTEM BW key is used in the C/N measurement mode to enter the noise bandwidth of the IF filter in the radio system under test. This facility in the 3708A ensures that the C/N ratio is defined at the output of the IF filter in the radio equipment by taking into account the receiver IF bandpass filter noise bandwidth. The NOISE BAND filter selected on the 3708A should be large enough to encompass the noise bandwidth of the external equipment see figure A-1.

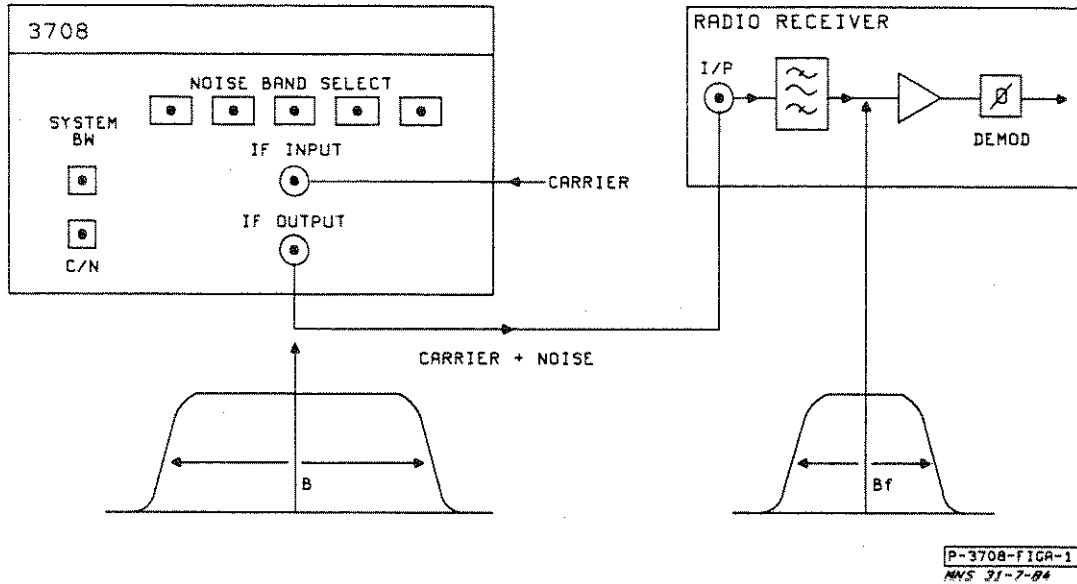

Figure A-1 3708A and RADIO RECEIVER Interconnection

For an entered Carrier to Noise (C/N) ratio, the generated Carrier to Noise Density (C/No) ratio at the IF OUTPUT is:

$$C/No = (C/N) \times \text{filter noise bandwidth, } B.$$

At the radio receiver input the C/No ratio remains constant at this value. However when the radio receiver contains a bandpass filter, the bandlimiting effect of this filter reduces the total noise power, thus affecting the C/N ratio which is now given by:-

$$(C/N) f = (C/N) \times (B/Bf) \text{ -----(1)}$$

Where:

- (C/N)f = C/N ratio after the bandpass filter in the radio receiver.
- C/N = C/N ratio at output of 3708A. i.e. before the bandpass filter.
- B = noise bandwidth of filter selected in the 3708A and
- Bf = noise bandwidth of the filter in the radio receiver.

From equation (1) it can be seen that to define the Carrier to Noise Power ratio at the demodulator input, the "correction factor" B/Bf has to be used. This calculation is performed automatically by the 3708A

when the SYSTEM BANDWIDTH is entered i.e. using the system BW key. The instrument still generates noise in the band defined by the NOISE BAND selection BUT the noise power is adjusted to define the C/N ratio entered at the radio IF bandpass filter output.

The following procedure illustrates how to set a defined C/N ratio at a monitor point in a radio receiver. If the radio receiver operates with a 70MHz IF and has a noise bandwidth of 30MHz; to set up a C/N ratio of 10dB with a carrier of -5dBm, proceed as follows:

1. Connect the carrier signal to the 3708A IF INPUT.
2. Press C/N, 10, ENTER. (This selects a C/N ratio of 10dB).
3. Press 70±20
(This gives a noise bandwidth of typically 59.1MHz. If the DISP N key is pressed the noise power displayed should be approximately -15dBm).
4. Press SYSTEM BW, 30, ENTER
(This enters the system noise bandwidth of 30MHz i.e. approximately half the noise bandwidth in step 3. If the DISP N key is pressed once again, the result should be 3dB greater than in step 3. i.e. -12dBm indicating the noise power has doubled with a reduction to half the noise bandwidth - thus maintaining a constant C/N ratio at the IF filter output.

To return the 3708A to C/N operation using the internal NOISE BAND filters, press SHIFT, INTERNAL.

APPENDIX B

SELF TESTS

There are 29 self test sequences in the 3708A, sub-divided into four TEST GROUPS. The tests and the method of accessing them is as outlined below. If a particular test fails, refer to Table C-1, Self Test Error Codes contained in APPENDIX C.

TEST GROUP 0- Tests 1 through 7

Using the short cable supplied, connect the 0dBm REF OUTPUT to the POWER METER input. Press SHIFT, SELF TEST, 0.

Tests 1 through 5 - Check the processor.

Test 6 - Checks the EEPROM contents against a check sum.

Test 7 - Measures the level of the 0dBm REF OUTPUT and if it is within ± 1 dB assumes the error is in the Power Meter and generates a correction factor which is stored in volatile memory.

TEST GROUP 1- Tests 8 through 26.

Using the short cable supplied, connect the NOISE OUTPUT to the POWER METER input. Connect a cable across the external FILTER ports. Press SHIFT, SELF TEST, 1.

Test 8 - The NOISE OUTPUT is measured with the Variable Gain Stages, (A302 and A304) set to maximum, the Attenuator Assemblies, (A310 and A311) set to minimum and the External Filter selected.

Tests 9,10,11 and 12 -The power change is measured for each Power Meter Attenuator Section.

Test 13 - Checks the Noise Filter assemblies. The A304 Variable Gain Stage is set to maximum attenuation. The Noise Source is calibrated to give a 0dBm output at the front panel with the 70 ± 5 MHz filter selected. The level at the NOISE OUTPUT is measured via the cable from the NOISE OUTPUT to the POWER METER input.

Test 14 - As 13 but using the 70 ± 20 MHz filter.

Test 15 - As 13 but using the 140 ± 40 MHz filter.

Test 16 - As 13 but using the 10-200MHz filter.

Tests 18 through 25 - Checks the Noise Source Attenuators. The Noise Power is measured via the front panel cable with the Noise Source Attenuators (A310 and A311) set to 0dB, this power is stored in the 3708A memory.

Each section of A310 and A311 is selected in turn, the power is remeasured and the loss of each attenuator section calculated. The relationship between the tests and the particular attenuator sections is shown below:

Test 18	A310	1 dB section
Test 19	A310	2 dB section
Test 20	A310	4 dB section
Test 21	A310	4 dB section
Test 22	A311	10 dB section
Test 23	A311	20 dB section
Test 24	A311	40 dB section
Test 25	A311	40 dB section

Test 26 - Checks the variable gain. The A304 Variable Gain Stage is set to minimum attenuation, the A311 Noise Source Attenuator is set to 10dB and the NOISE OUTPUT power is measured via the front panel cable connection and stored.

The A304 Variable Gain Stage is now changed to maximum attenuation and the power is remeasured and compared with the last power measurement. The gain change in the A304 is now calculated.

TEST GROUP 2

Using two cables, connect the 0dBm REF OUTPUT to the IF INPUT and the IF OUTPUT to the POWER METER input. Press SHIFT, SELF TEST, 2.

Test 27 - Checks the IF INPUT to IF OUTPUT path. The 0dBm REF OUTPUT level is measured via the 2 front panel connections and the internal path between the IF INPUT and IF OUTPUT.

Test 28 - Checks the IF INPUT to power meter section path. The 0dBm REF OUTPUT level is measured via the front panel connection and the Carrier Measure path within the 3708A.

TEST GROUP 3.

Connect a cable from the 0dBm REF OUTPUT to the Rear Panel AUX INTERFERER INPUT and from the IF OUTPUT to the POWER METER input. PRESS SHIFT, SELF TEST, 3.

Test 29 - Measures the insertion loss from the AUX INTERFERER INPUT to the IF OUTPUT. The 0dBm REF OUTPUT is measured via the AUX INTERFERER INPUT.

APPENDIX C

SELF TEST ERROR CODES

When a particular SELF TEST routine fails, an error code is displayed in the right hand display. This error code consists of the number of the test that failed followed by the letter F. The number in the left hand display is the difference between the nominal and test result.

Table C-1 contains information on the probable fault location related to a self test failure.

Table C-1 Self-Test Error Codes

Self Test Error Codes	Probable Fault Location
1F to 5F	A201 Microprocessor Assembly.
6F	A201 Microprocessor Assembly or the instrument requires recalibration.
7F	a) A 306 OdBm Reference Source, b) Power Meter section.
8F	a) Noise Source section, b) Power Meter section.
9F to 12F	a) A402 Input Attenuator Assembly, b) A203 Interface Assembly.
13F to 16F	a) A303 Noise Filter Assembly, b) A309 70 ± 5MHz Noise Filter Assembly.
17F	This SELF TEST is an internal set up condition for the instrument.
18F to 25F	a) A310 Units Attenuator, b) A311 Decade Attenuator, c) A203 Interface Assembly.
26F	a) A304 Variable Gain Stage, b) A204 Variable Gain Control Assembly.
27F	A407 Injection Assembly. Check amplifier U1 d.c. conditions at TP1 and TP2.
28F	A407 Injection Assembly.
29F	A407 Injection Assembly.

NOTE : This table is intended to be used only as an indication to where the fault is located.

INDEX

A

ASCII Characters	Page(s) 47, 48 and 81
AVERAGE N	7, 20 and 37
Accessories Supplied with 3708A	70
Address Switch	47, 49 and 80
Addressing the 3708A	47
Appendix A	
Appendix B	
Appendix C	
AUXiliary INTERFERER INPUT	15, 29 and 34
Averaging	20

B

Bit Rate	Page(s) 6, 33 and 40
Bandpass/Band stop filters	see NOISE BAND Filter
Binary Mode	53
Bus Commands	56, 59 and 62

C

C/I (Carrier to Interference) Measurement	Page(s) 34
C/N (Carrier to Noise) Measurement	30
C/N mode - Additional Features	31
C/No (Carrier to Noise Density) Measurement	32
C/No mode - Additional Features	32
CALIBRATION CYCLE	18 and 21
CALIBRATION CYCLE - Inhibited	18
CARRIER + NOISEBAND/OR INTERFERENCE MIXER	29
CARRIER POWER Measurement at IF INPUT	41
CARRIER POWER - Entering/Cancelling	36
CARRIER TO INTERFERENCE MEASUREMENT MODE	34
CARRIER TO INTERFERENCE Ratio Set up	40
CARRIER TO NOISE MEASUREMENT MODES	29
CARRIER TO NOISE Ratio Set up	40
Cables (HP-IB)	46 and 79
CANCEL C	5 and 36
Capability - HP-IB	47

D

DATA ENTRY keys	Page(s) 8
Data Message Commands (key-action)	59
Data Message Commands (functional)	62
Default Parameter	42 and 56
Device Clear	56
DISPlays (front panel)	2, 13 and 14
DISPlaying the Address	47
DISPlay N	6 and 31
DISPlay No	6 and 31
DISPlay I	6
DISPlay C	6 and 31

E

Eb/No (Energy per Bit to Noise Density) Measurement	Pages 29 and 33
Eb/No Mode - Additional Features	33
ENERGY PER BIT TO NOISE DENSITY Ratio Set up	40
ENTER (Insertion Loss)	9
ENTER C	5 and 36
ENTER N BW	12 and 24
EXT FILTER keys	12
EXT FILTER mode	23
Error Codes (Self Test)	APP C

F

Failure/Error Codes (Self Test)	APP C
Filter (External Filter)	12, 23 and 38
Formatting (HP-IB messages)	50
Front Panel Keyboard	3
Front Panel Displays	13 and 14
Front Panel keys	45 thru 12
Fuses	15 and 76

G

GENERATE (Noise Generation)	Page(s) 14 and 29
GP-IB (General Purpose Interface Bus)	see HP-IB
General Information	69

H

HP-IB

Addressing the 3708	Page(s) 47
Address Switch	47 and 49
ASCII characters	48
Binary Mode	53
Capability	47
Connecting to HP-IB	79
Cables	46 and 79
Displaying the Address	47
Data Message Commands (key action)	59
Data Message Commands (functional)	62
Default Parameters	55
Message Format	50
Measurement Codes	51
Operating Distances	46
Preset Address	47
Reading Data from the 3708A	50
Remote Operation	49
Service Request (SRQ)	54
Status Byte	54
Status Request	53
SRQ Mask	55
SRQ ON/OFF	55
Sample Program	66
Simple Programs	52
Talk/Listen Address	47
Universal Commands	56

I

I LEVEL (annunciators)	Page(s) 14, 34 and 41
IF INPUT	11
IF OUTPUT	11
INTERNAL (key)	5
Instrument Description	1 and 70
Insertion Loss	9, 25 and 27
Insertion Loss Measurement	25
Interference Displayed on Front Panel Display	41
Interface Clear	57
Instrument Inspection Before Use	73
Instruments Covered by Manual	69
Interference Input	12 and 34
Interferer (AUX) Input	34

K

Keys (front panel)	Pages 4 thru 12
--------------------------	-----------------

L

Line Voltage Selection	Page(s) 74
Listen Address	47, 48 and 80
Local (HP-IB)	57
Local Lockout (HP-IB)	58

M

MEASURE	Page(s) 14
MEASure I	6 and 35
MODE keys	5 thru 7
Measurement Codes (HP-IB)	51
Message Format (HP-IB)	50

N

NOISE BW keys	Page(s) 9
NOISE BAND key	10 and 11
NOISE GENERATOR	21
NOISE OUTPUT	10 and 22
NOISE BW (bandwidth)	25
NOISE POWER (N) Generation	22 and 38
NOISE DENSITY (No) Mode	22 and 38
NOISE BAND Filter Selection	22 and 38
NOISE OUTPUT Disabled	24
NOISE BW (bandwidth) Measurement	27 and 41
NOISE displayed on the Front Panel Display	41
NOISE BANDWIDTH of an External System	39
Numeric keys	8

O

OPERATOR'S CHECKS	Page(s) 43
OUT OF RANGE	13
Operating Distances	46 and 78
Operating Environment	77
Options	70

P

POWER METER Averaging	20
POWER METER Measurement	Page(s) 19 and 37

POWER METER Zero Calibration	20 and 37
Parameter (default)	42 and 56
Packaging (storage and shipment)	76
Power Cables	74
Power Requirement	74
Preparation for Use	75

Q

Quick Measurement Settings	Pages 37 thru 42
----------------------------------	------------------

R

REFERENCE SOURCE (0dBm)	Page(s) 18
REFERENCE SOURCE (0dBm) Common Uses	18
Rack Mounting	77
Remote Operation.....	49
Reading Data from the 3708A	50
Remote Operation	49
Rear Panel Switches and Connectors	15 and 16
Remote Enable	57

S

SELECT (EXT FILTER)	Page(s) 12 and 38
SELF TEST	66 and App. B
SHIFT	8
SRQ Mask (HP-IB)	55
SRQ On/Off (HP-IB)	55
Sample Program (HP-IB)	66
Selection Device Clear (HP-IB)	56
Service Request (HP-IB)	54
Self Test Errors	App. C
Serial Poll	54
Serial Number	15 and 69
Simple Programs (HP-IB)	52
Specifications	71
Status Byte (HP-IB)	54
Status Request (HP-IB)	53
System Bandwidth	5, 30 and App. A

T

TRANS N BW	Page(s) 12 and 24
Talk Address	48 and 80

Tracking	36
Track Inhibit	13 and 36
Trigger	57

U

Universal Commands	Page 56
--------------------------	---------

W

Weight	Page 73
--------------	---------

1 WHAT IS THE HP 3708A?

What is the HP 3708A?

The HP 3708A Noise and Interference Test Set generates specific noise levels and is made up of the following functional parts (see also Figure 1-1).

- NOISE GENERATOR
- POWER METER
- INJECTION HEAD (signal mixer)

The Injection Head mixes the incoming IF carrier signal with noise and/or an interference tone, to produce defined carrier to noise ratios (C/N).

In addition to generating specific noise levels and producing defined C/N ratios, the 3708A can make the following measurements:

- power
- insertion loss
- noise bandwidth

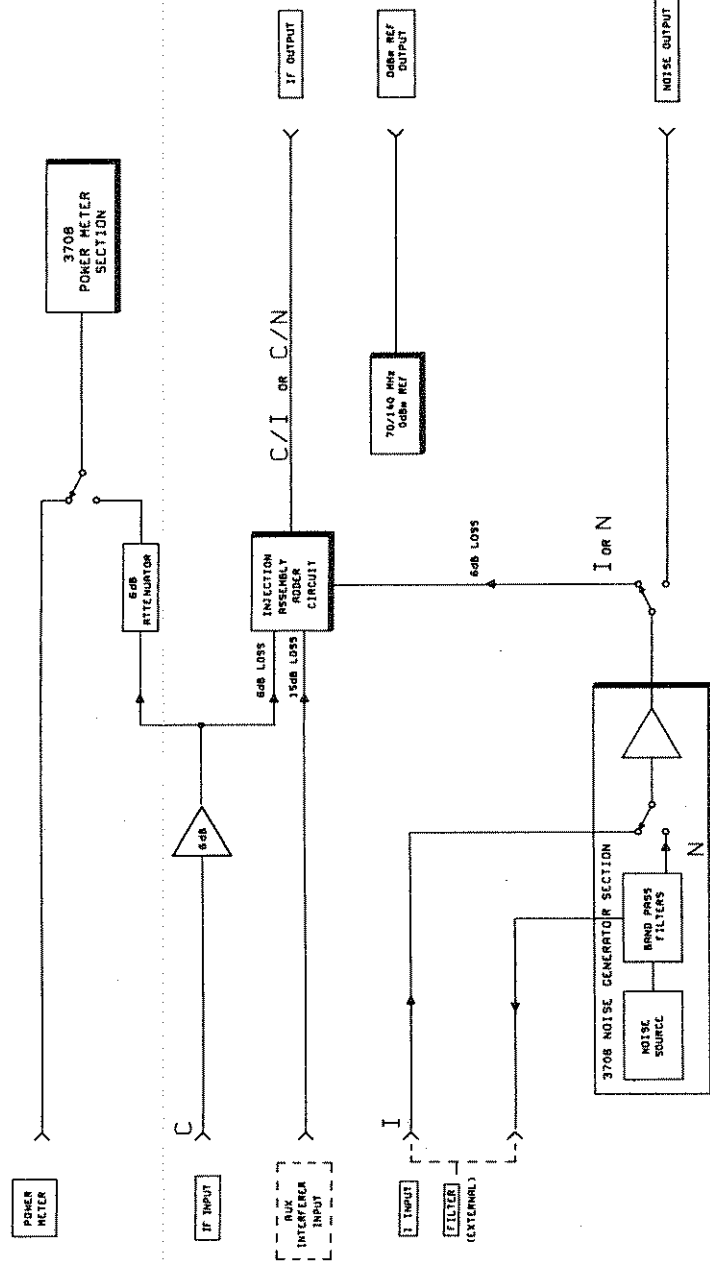

Figure 1-1 3708A Simplified Block Diagram

Continued inside fold

Where is the HP 3708A used?

The 3708A has been designed primarily for use with digital radios. The instrument allows the user to select a wide range of highly stable carrier to noise ratios with the added flexibility of inserting an interference tone either with noise or in place of the noise.

Use of the internal Power Meter and microprocessor control enables a constant carrier to noise (C/N) ratio to be maintained at the Injection Head regardless of the received carrier power variations. The instrument provides a simple and accurate method of simulating flat-fade conditions on a microwave link.

A typical hook-up involving a digital radio system and a 3708A is illustrated in Figure 1-2.

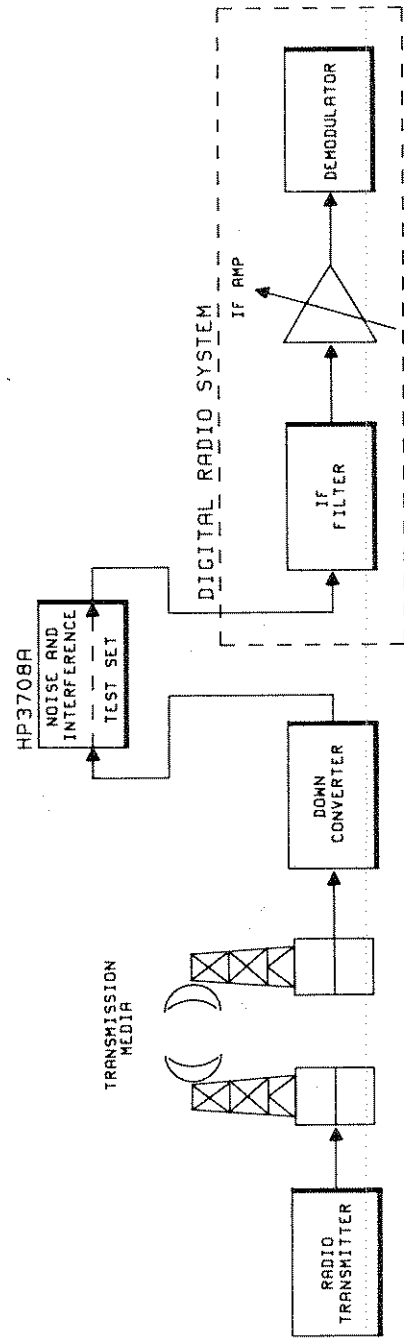

Figure 1-2 Using the 3708A in a Radio System

Note: Some of the keyboard LEDs (in the centre of keys) flash continuously when selected. This indicates that this mode is ready for data entry and can be altered if required.

Key functions marked thus " " (printed in blue on the front panel) are selected by first pressing the blue SHIFT key.

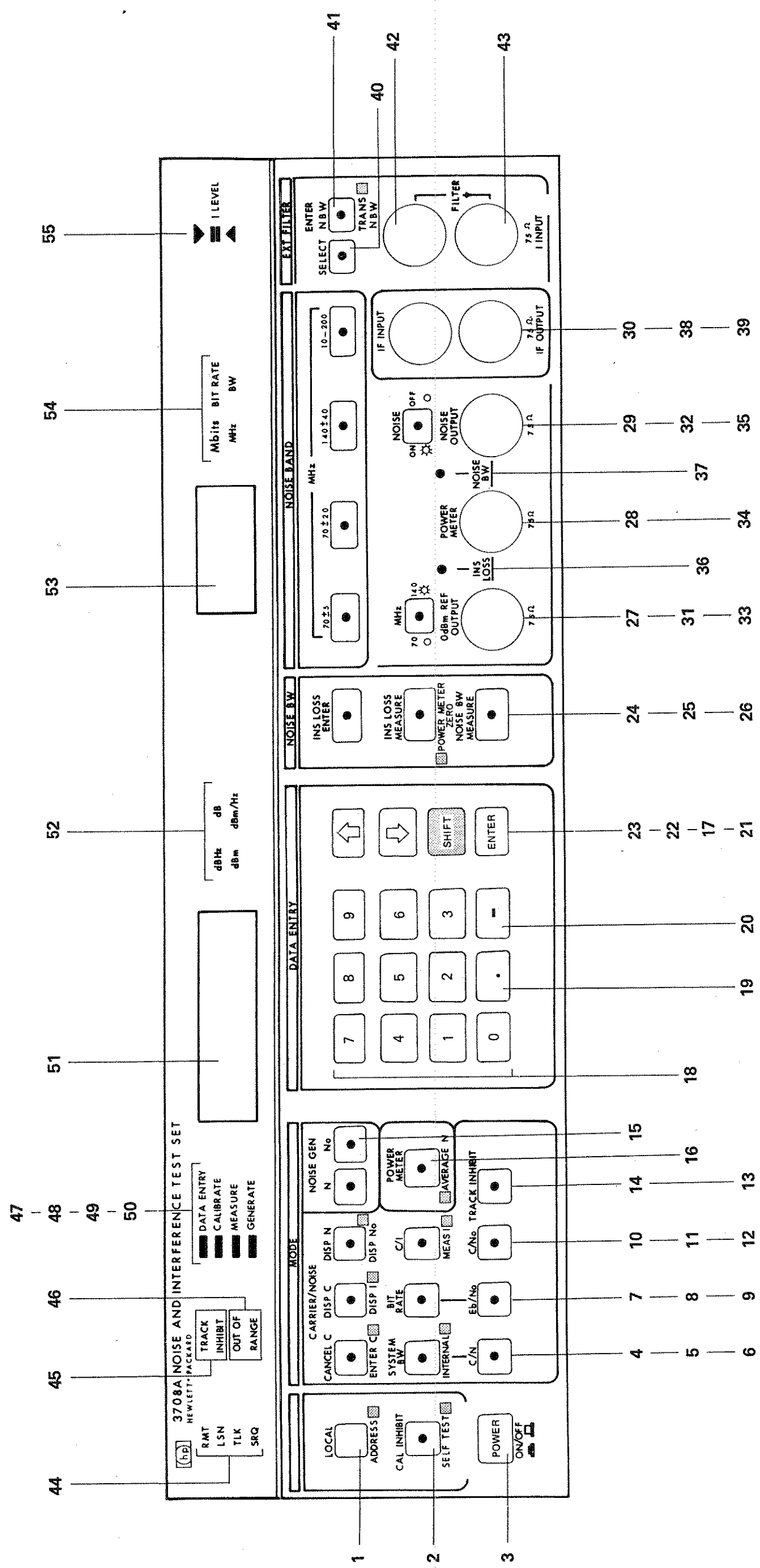

Figure 2-1 3708A Front Panel

